

8' x 8' Aurora Light Box

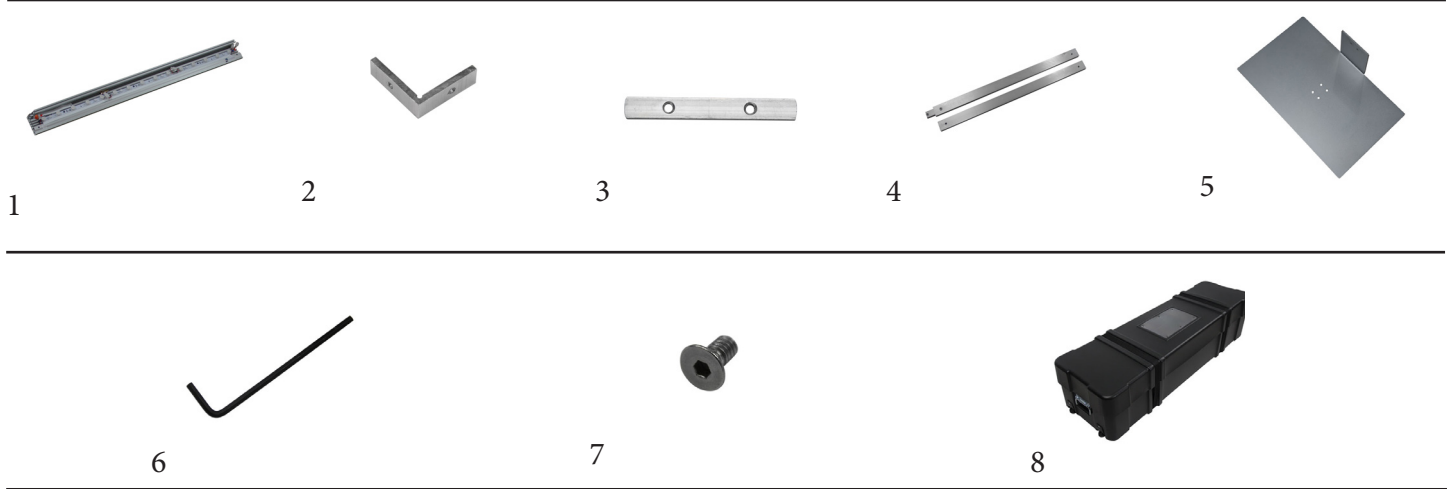

Parts



1 - (8) Extrusions
2 - "L" brackets
3 - Straight brackets

4 - (2) Vertical Support bar
5 - (3) Feet
7 - Allen wrench

8 - Screws
9 - Shipping case

Replacement Parts (Sold Individually)

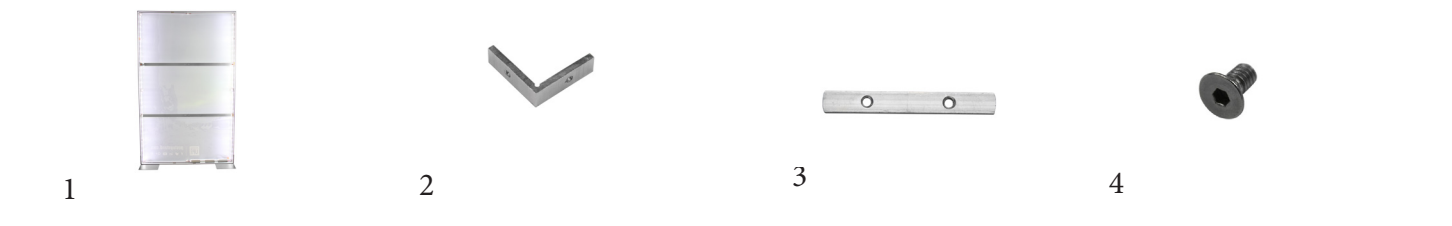

1 - Full frame replacement
(includes all hardware
components listed)

2 - "L" brackets

3 - Straight brackets

4 - Screws

Storage and care

Place all components of the Aurora Light Box into designated areas of case and store in a cool, dry place.