

INSTRUCTION

Follow the label instructions to assemble the frame

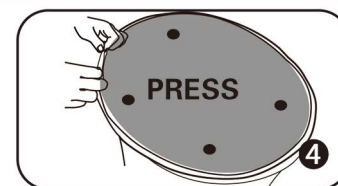

If the tubes do not easily separate when dismantling, push the tube forward then pull out again

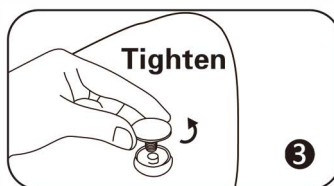
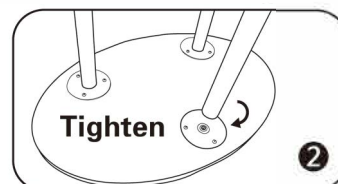
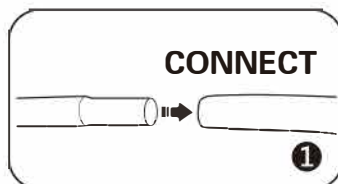

Front

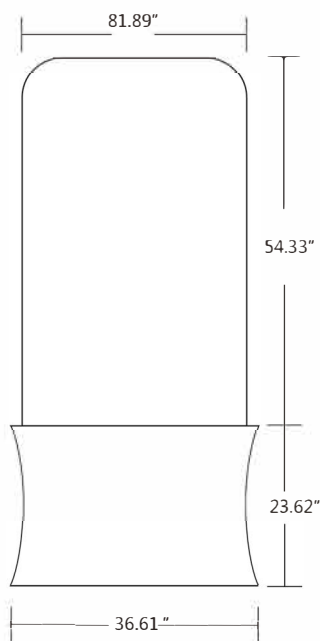

Holes in Graphic to Assemble Shelves

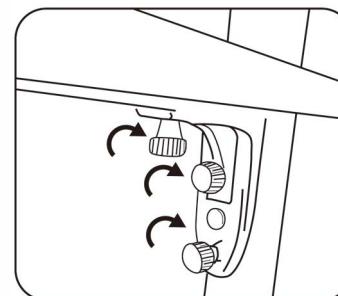
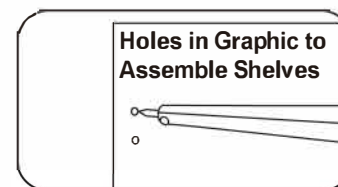

Top

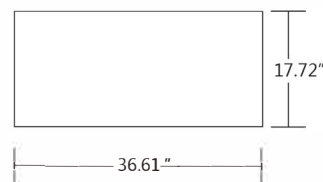

Graphic Size :

Top: W 33.07" X H 55.12"

Bottom: W 92.13" x H 25.98"