

# User Manual



**Model:** DGAFR32, DGAFR32S

**Description:**

32” Indoor A-Frame Digital Sign

**Scan QR code to visit the product page:**



## **Operating Instructions for Digital Signage**

Note: Before using the product, please read the instructions carefully!

Do not attempt to disassemble this product. If the product does not work properly, please call our Customer Service Department at 1-844-221-3393.

## Contents

<b>Features .....</b>	<b>3</b>
<b>Safety Warnings and Precautions .....</b>	<b>3</b>
<b>Assembly and Connection .....</b>	<b>5</b>
Packing List.....	5
Interfaces .....	6
Steps for Assembly.....	6
<b>Remote Control .....</b>	<b>7</b>
<b>Description of Basic Operation .....</b>	<b>8</b>
Power on/Standby .....	8
About Launch Desktop.....	8
Description of Wallpaper Switch.....	9
File Manager .....	9
Local Settings .....	10
Status of Menu bar .....	11
<b>Slide Show APP Introduction.....</b>	<b>11</b>
How to Upload Media Files .....	11
How to Delete Media Files.....	16
Factory Reset.....	18
Screen Rotate.....	18
Choose System Language.....	19
<b>Technical Specifications.....</b>	<b>20</b>
<b>Troubleshooting.....</b>	<b>22</b>
<b>Cleaning and Maintenance.....</b>	<b>24</b>
<b>Names and Contents of Toxic and Hazardous Substances or Elements in the Product.....</b>	<b>25</b>





## Features

1. Embedded with Android 5.1 smart operating system and unique UI design, bringing you a more convenient operation and better visual experience.
2. Support USB mouse and keyboard, realizing easy manipulation like a computer. Using a mouse for set up is recommended.
3. Built-in Wi-Fi module, high capacity memory and high capacity cache, making it smoother to watch 1080P HD movies and play big games.
4. High-quality LCD screen as the display, no flicker, low radiation, greatly reducing eye fatigue, eye protection, high brightness, high contrast, and wide viewing angle; ultra-fast response time greatly reduces ghosting of fast moving images.
5. Progressive image processing and industry-leading motion compensation technology improve the flickering and blurring in the edges of motion picture.
6. Dynamic contrast technology can significantly improve the clarity and contrast of various screens.
7. Multi-channel USB interfaces, supporting HD media streaming.
8. Ultra-thin narrow bezel design.

## Safety Warnings and Precautions

Thank you for purchasing the high-performance multi-functional LED backlight Digital Signage from Displays2go. We have considered the factors to ensure personal safety in product design and have tested rigorously at the factory. However, improper installation and use may result in electric shock and fire. In order to safely use, maximize performance of the unit and extend the life of the product, please read and follow all instructions carefully before using the product. Keep the instructions for future reference.

### Symbol Legends:

-  **Warning: May cause personal injury or death**
-  **The operation is prohibited**
-  **Caution: May cause damage or property loss**
-  **The operation must be executed**

### If any of the following occurs:

- Power outage or instable voltage.
- Abnormal sound or smell from the unit.
- AC power cord is damaged.
- Digital Interactive Table is damaged due to drop, knock or impact.
- Any liquid or foreign matters fall into the enclosure.



**Turn off the Digital Interactive Table immediately, pull out the plug from the power outlet, and ask the authorized personnel for maintenance timely.**

 **If coal gas or other flammable gas leaks, do not pull out the plug of the LCD Digital Signage or other electrical appliances; instead, turn off the gas valve immediately, and open the doors and windows quickly.**

 **WARNING**

- ⊘ ● Do not use power supply other than AC 110V, 50Hz.
- Cut off the power supply before connecting or disconnecting any cables.
- Do not place the Digital Signage on any instable positions, or else it may be damaged or cause fire.
- Do not place the Digital Signage in the positions such as:
  - 1.The environment subject to direct strong sunlight, moisture, extreme temperature or too much dust;
  - 2.The environment with flammable or explosive materials;
  - 3.The environment with flammable or corrosive gases;
- Do not use damaged or inappropriate power outlets and ensure that the plugs and outlets contact properly.
- Do not let dust or metal deposits adhere to the plugs and outlets.
- Do not damage the power cords:
  - 1.Do not modify the power cords;
  - 2.Do not place heavy objects on the power cords;
  - 3.Keep the power cords away from heat source;
  - 4.Do not pull the cord to remove the plug.
- Do not connect too many plugs to one outlet in parallel, or else it may cause fire due to excessive power consumption.
- Do not approach the Digital Signage with open flame (e.g. a lighted candle), or else it may cause electric shock or fire.
- Do not put water filled container on the Digital Signage to avoid electric shock and fire due to water drops or splashing.
- Do not put any sharp objects, metal or liquid into the vents or let them touch the signal terminals to avoid short circuit, product damage, and electric shock.
- The openings in the enclosure are designed for ventilation and cooling, to ensure long time reliable running of components inside the enclosure and prevent overheating. Do not block the openings when place the unit.

⊘ Do not touch the plugs with wet fingers, or else it will cause electric shock.

Do not use the Digital Signage in stormy weather, especially when there is lightning; instead, please disconnect the power and antenna plugs to avoid lightning strike.

⊘ Do not disassemble the Digital Signage without permission, or else it may cause electric shock or fire. Please ask qualified technician for repair.

**⚠ CAUTION**

- Do not let children climb onto the Digital Signage.
- Keep the small parts away from children to prevent them from swallowing.
- If the Digital Signage won't be used for a long time, please turn it off and pull out the power plug.
- To adjust the position or angle of the Digital Signage, please disconnect all power cords and move slowly to avoid falling.
- Do not scratch or knock the LCD with hard object, or twist and squeeze the LCD.
- Do not turn on the unit immediately when it is moved from a place with low temperature to high temperature, or else it will cause condensation and malfunction.
- Before cleaning the Digital Signage, please pull out the power plug; wipe with soft cloth; do not use industrial chemicals; prevent foreign matters from entering the machine. Improper cleaning (such as cleaning solution, water) may damage the product, erase the printed information, and even cause damage of the components if fluid flows in, resulting in machine failure.
- If the unit displays the same screen for a long time or the moving picture has fixed text or icon, it will leave ghosting on the screen and won't disappear when the unit is turned off; it is normal and isn't covered by the warranty.
- The power of the Digital Signage can be cut off by pulling out the plug.
- If the LCD screen ruptures and the liquid splashes on the skin, please rinse for 15 minutes with clean water immediately, and consult your doctor.
- To carry the Digital Signage with hands, please grab the corners and hold the bottom; do not apply pressure on the panel.
- Use the Digital Signage properly: Use in proper lighting conditions; insufficient lighting or long time watching will impair your eyesight.
- When the plug or coupler is used as disconnection device, it should be easy to operate the device.
- Insert the plug into the outlet properly, or else it may cause sparks and fire.
- The technical specifications printed herein and on the packaging are subject to change without prior notice. The Manual may be slightly different from actual operation, and the latter is applicable.

## Assembly and Connection

### Packing List

Name	
1 Digital Signage	●
1 Remote Control	●
1 Operation Manual	●

Name	
1 Power Cord	●
1 Cleaning Kit	●

**Note:**

Contact local dealer if you have questions about the operation, debugging and connection of the unit; if the unit doesn't work normally, please cut off the power immediately and consult the dealer. The unit is class-A product, which may cause radio interference in living environment. In this case, please take feasible measures, and use power plug as the disconnection device.

## Interfaces

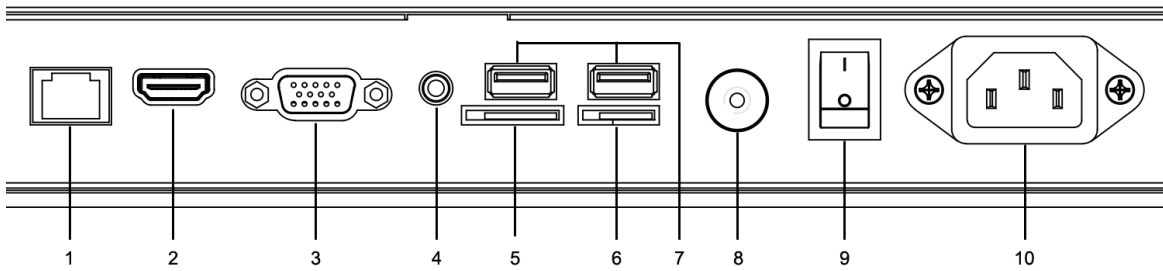

- 1.RJ45 interface; 2. HDMI input; 3. VGA input; 4.Audio input; 5. SIM card;  
6.TF card ; 7.USB interface; 8.Antenna/WIFI interface; 9.On/off button; 10.Power port;

Note: Please pull out the power plug before installing or disassembling the unit!

## Steps for Assembly

1. Open the top cover as shown in Fig. 2;
2. Remove the unit shown in Fig 3 and place it on the ground (avoid scratches)(Fig 4);
3. Open the bottom bracket to make the machine stand up, as shown in Fig 5.

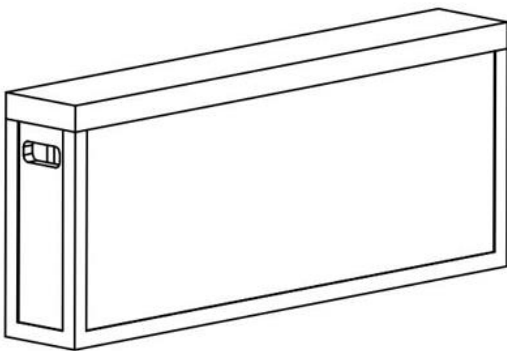

(Fig. 1)

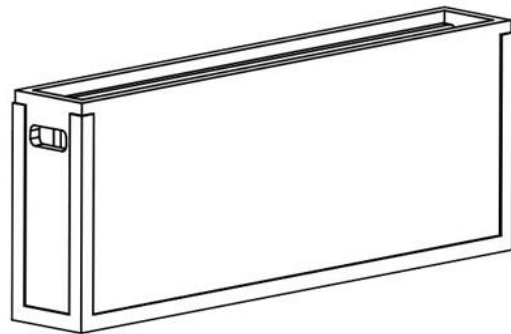

(Fig. 2)

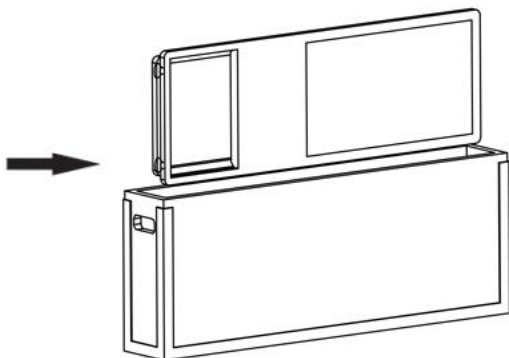

(Fig. 3)

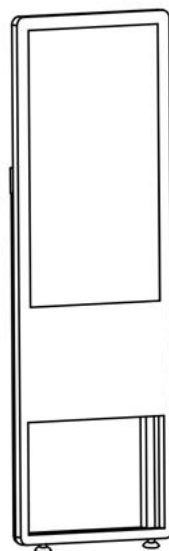

(Fig. 4)

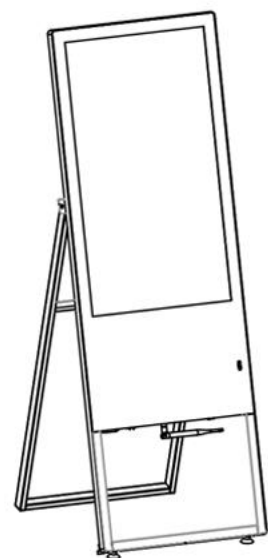

(Fig. 5)

## Remote Control

### Installing batteries for the remote control:

Remove the battery cover and insert two AAA batteries (1.5V). Ensure that the battery polarity matches the “+”/“-” marks in the battery compartment of the remote control.

### Precautions for using the remote control:

- Aim the remote control at the receiver window. Do not place any object between the remote control and the receiver window to avoid interference with the normal operation.
- Keep the remote control away from violent vibration. In addition, do not set or place the remote control in direct sunlight, or else the remote control may be deformed by heat.
- The remote control may be invalid when the receiver window of the unit is in direct sunlight or strong lighting; in this case, please adjust the angle of the lighting or the unit or approach the receiver window to use it.
- The distance of remote control will be shortened if the battery voltage is insufficient; in this case, please replace with new batteries; if the remote control won't be used for a long time or the batteries are run out, please take out the batteries to avoid corrosion due to battery leakage, which will damage the remote control.
- Do not use batteries of different types or mix new batteries with old ones. Always replace the batteries in pairs.
- Do not put the batteries in fire, or charge or disassemble them, or charge, short circuit, disassemble, heat or burn used batteries. Please dispose of waste batteries in accordance with local environmental regulations. Do not expose the batteries in overheated environments such as sunlight and fire.

### Description of remote control buttons:



Note: Press the SETUP button in the main interface to call out the OSD menu. After exiting the playback mode by pressing the STOP button, the playback will start according to the schedule next time.

**Remark: The real appearance of the remote control may be different from the picture, please refer to the actual product.**

Button	Function
POWER (⏻)	Power switch
MENU	To show the main menu
SETUP	To set up OSD menu
SOURCE (↺)	To show the Source menu
▶ /	Play programs; confirm selection
▲	To move the cursor up
▼	To move the cursor down
◀	To move the cursor left
▶	To move the cursor right
◀◀	Previous program
▶▶	Next program
■	Stop playing and return to the main interface
🔇	Mute
🔊+	Turn up the volume
🔊-	Turn down the volume
HDMI	Select HDMI device as the source
VGA	Select VGA device as the source
↶	Back

## Description of Basic Operation







### Power on/Standby

Insert the power plug into the outlet. If the Digital Signage has the switch button “I”, turn it on; if you press the switch button “O”, the Digital Signage enters standby state.

In power on state, enter “System Assistant” and press the “⏻” button on the remote control, and the Digital Signage enters standby state.

### About Launch Desktop

#### Description of Desktop Icons

Icon	Function
	Main applications
	Back
	Home page
	Background applications
	Sound -
	Sound +

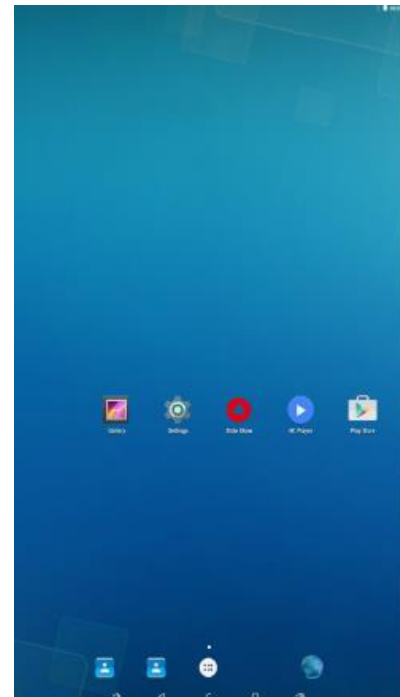



## Description of Wallpaper Switch

As shown on the right, tap and hold in the blank space to enter wallpaper switch interface, and select the wallpaper from different sources.

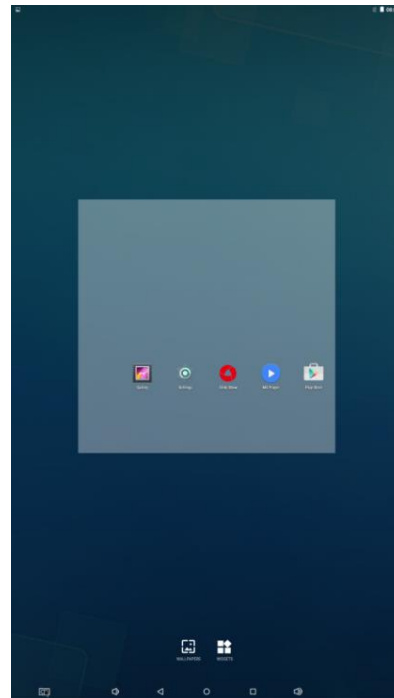

## File Manager

1. Click the Main Apps button “” in the Home page to enter the “APPS” menu interface (Fig. 2);
2. Click the “Explorer” icon in the “APPS” menu interface (Fig. 2) and enter “Explorer” menu (Fig. 3);
3. Click options in the “Explorer” menu to read the files from different devices.

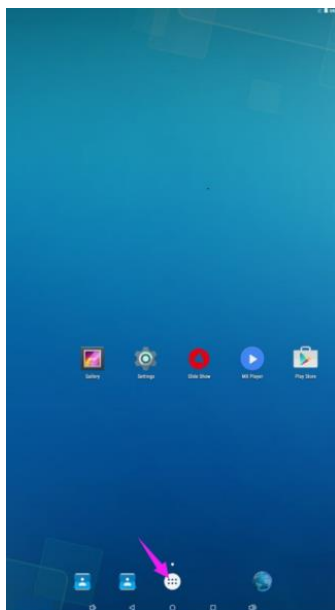

Fig. 1

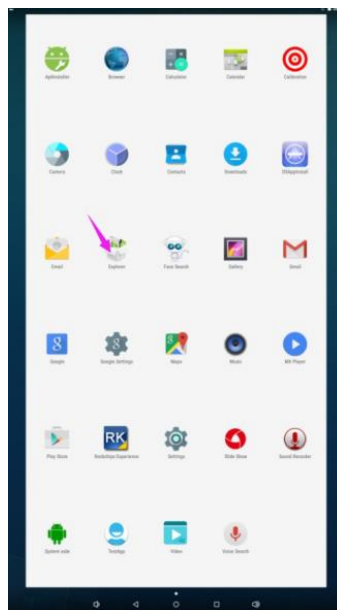

Fig. 2



Fig. 3

## Local Settings

1. Click the Main Apps button “

Fig. 1

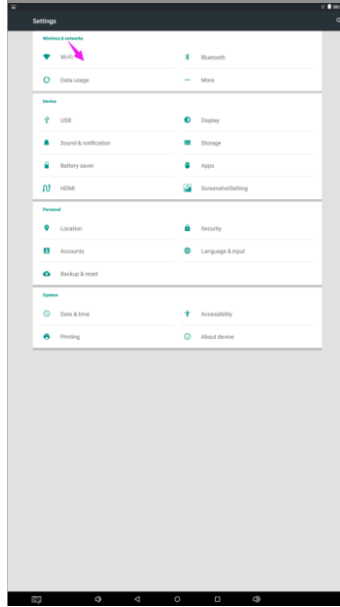





















Fig. 2



Fig. 3

### Description of Settings Interface (shown on the right)

Icon	Function
	WIFI switch
	Data usage
	Bluetooth
	USB
	Sound & notification
	Battery saver
	HDMI
	Display
	Storage
	Apps
	Screenshot Setting
	Location
	Accounts
	Backup & reset
	Security
	Language & input
	Date & time
	Printing
	Accessibility
	About device

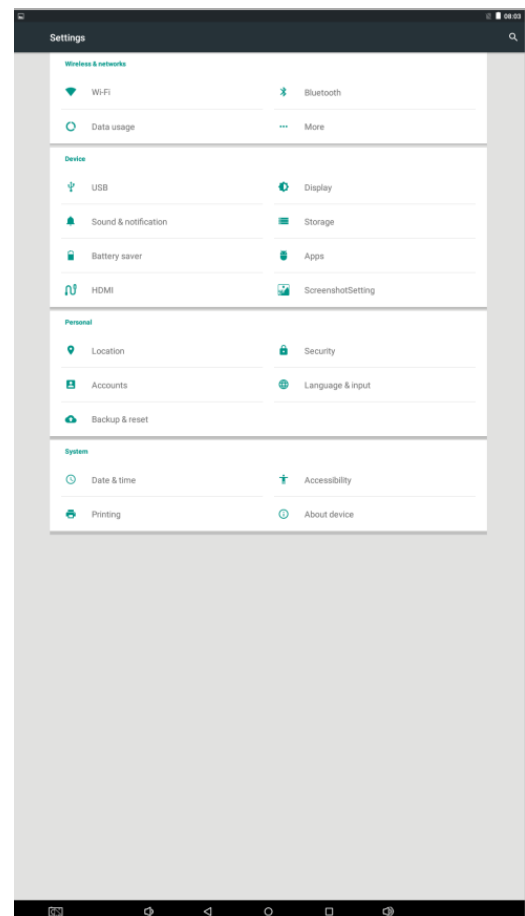

## Status of Menu bar

1. Step1: Click the setting
2. Step2: At the setting menu click the display menu
3. Step3: At the display setting menu unselect the display navigation check box

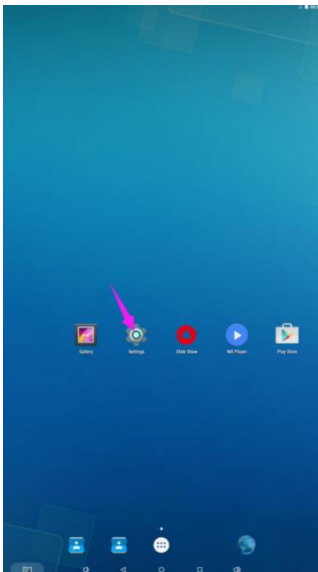

Fig. 1

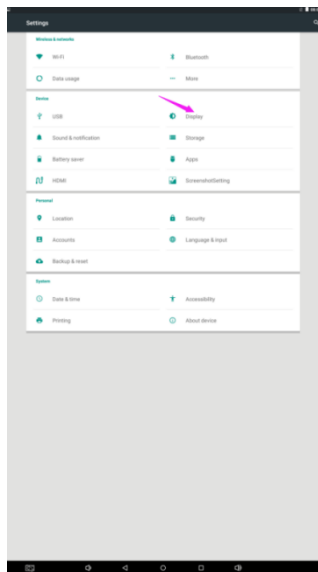

Fig. 2

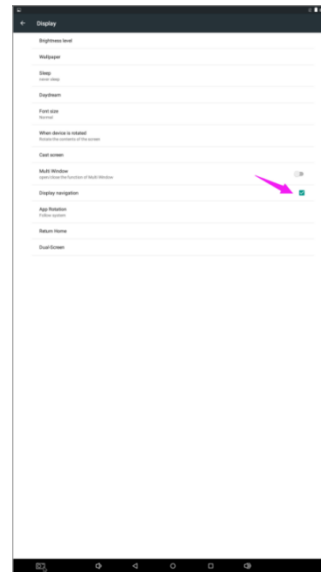
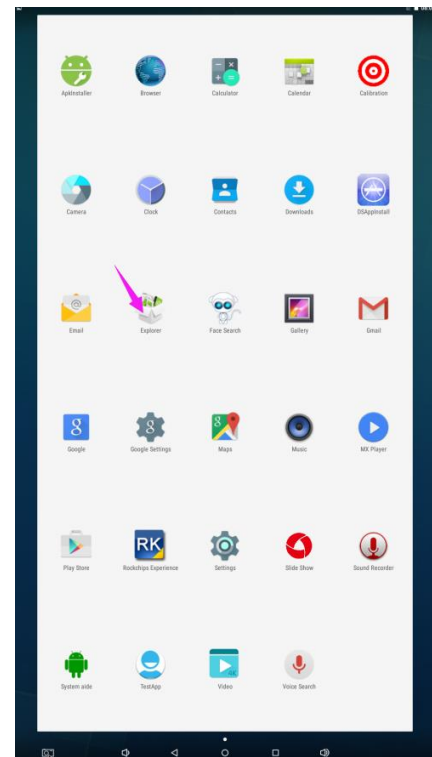
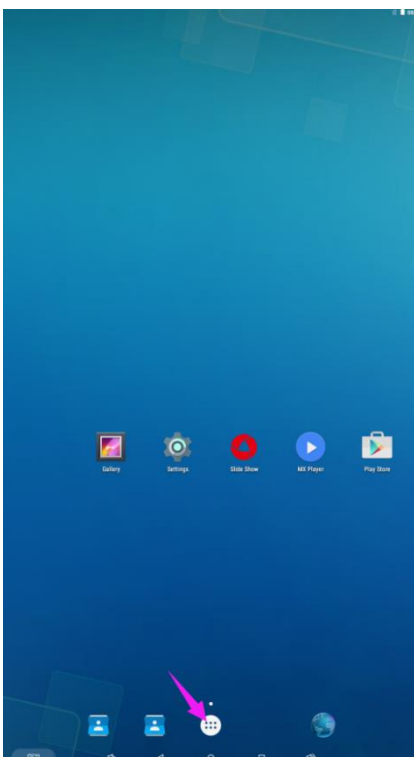

Fig. 3

## Slide Show APP Introduction

### How to upload media files :

Step 1: Open the Android launcher screen and click the explorer app



Step 2: Go to the USB storage menu click the USB storage button

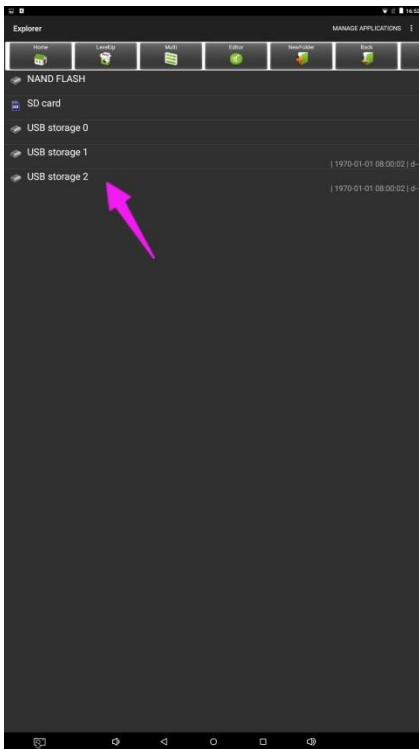

Step 3: At the USB storage menu select Multi and then highlight the media files which you want to copy to the media folder. Click the Editor button, the pop menu will show then click the Copy

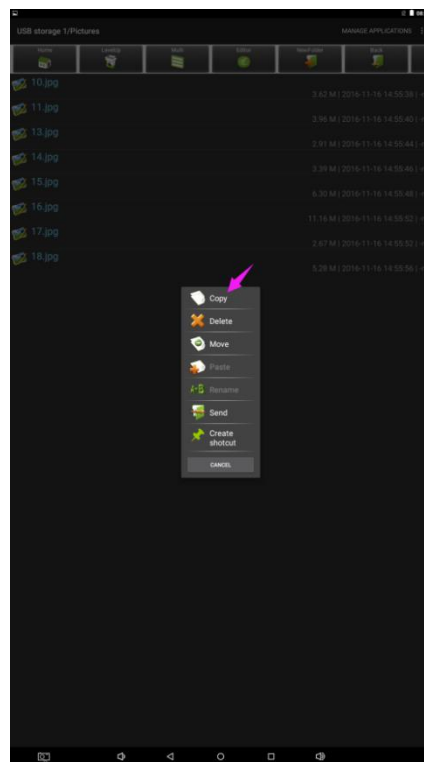
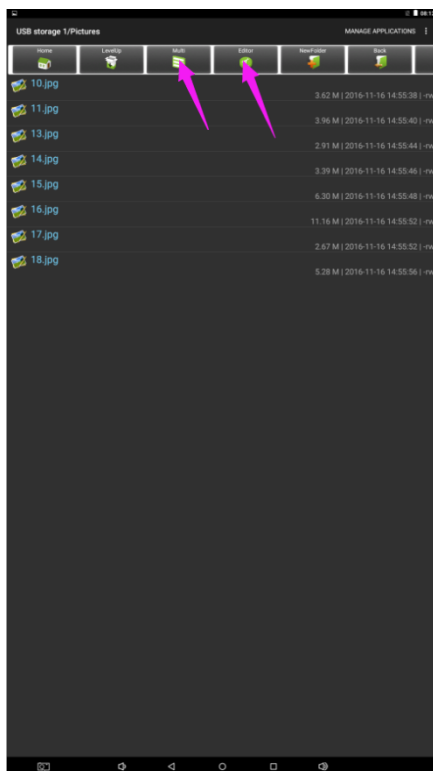

Step 4: Click HOME button and go to the NAND FLASH menu.

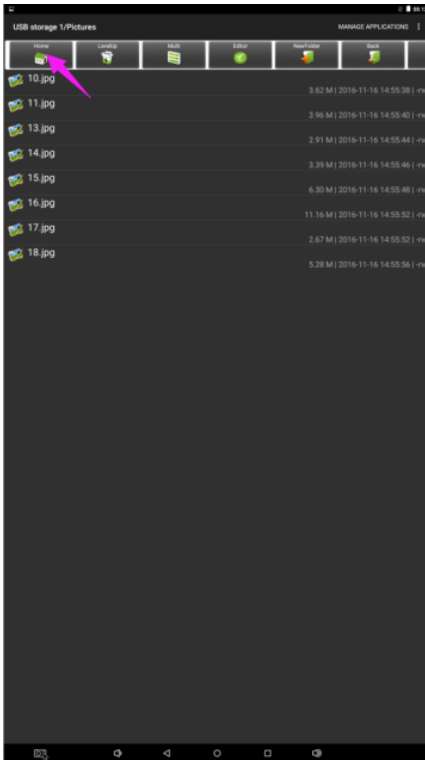

Select MediaFolder and then open the Images Folder.

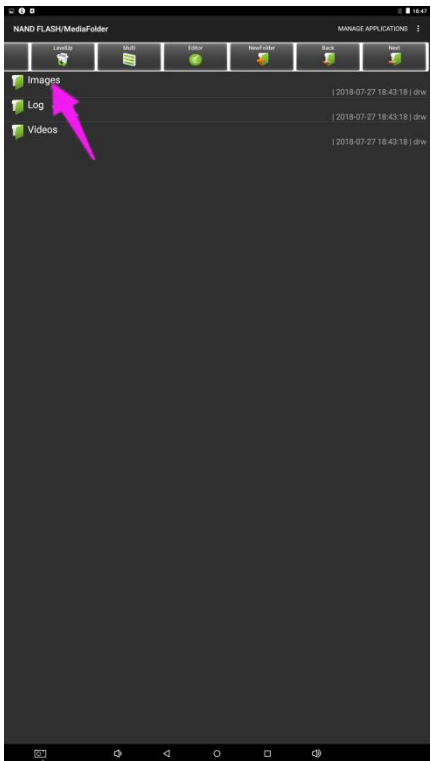
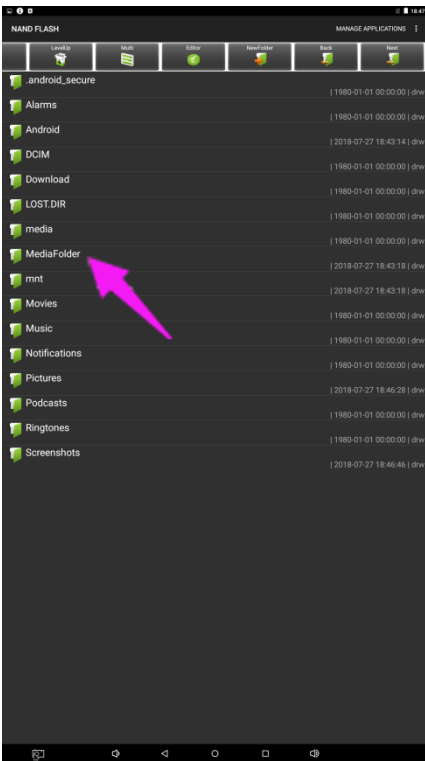

Step 5: At the images folder click the edit button at the top of the screen, the pop menu will show. Then click the Paste command button. The files will be copied to the images folder.

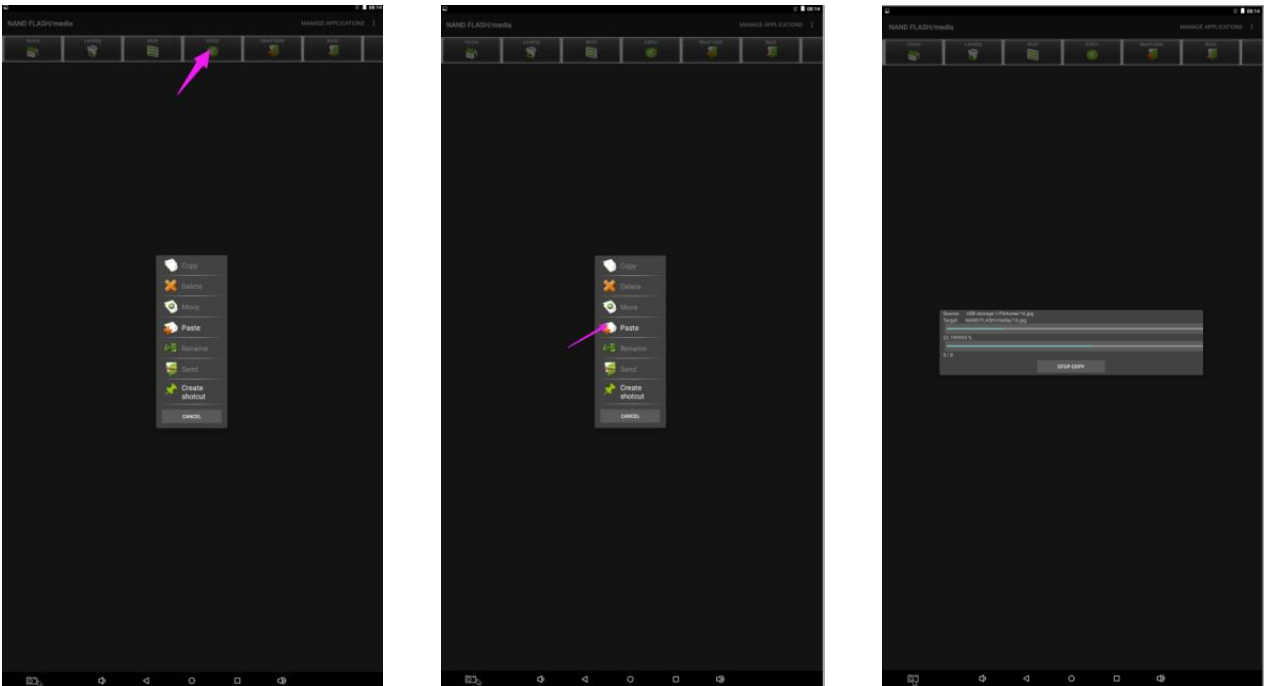

Step 6: Exit the Explorer app and go to the launcher screen. Run the Slide Show app to display the media files

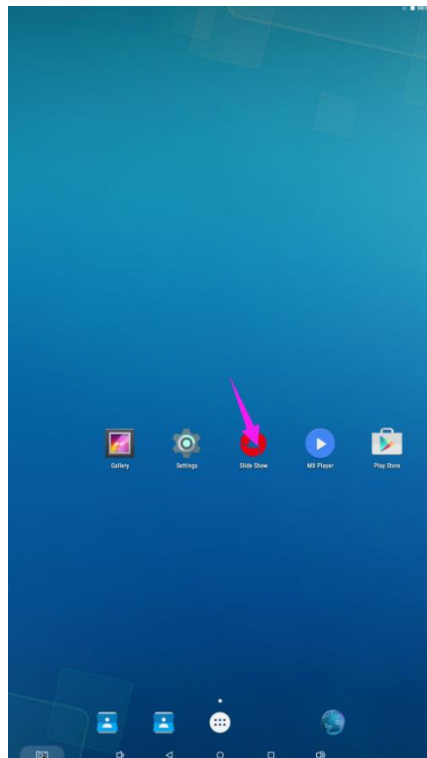

Step 7: Select the time you would like each picture to be on the screen for by dragging the bar to the desired time. Select how you would like the images to display. Select the desired transition effect between pictures.

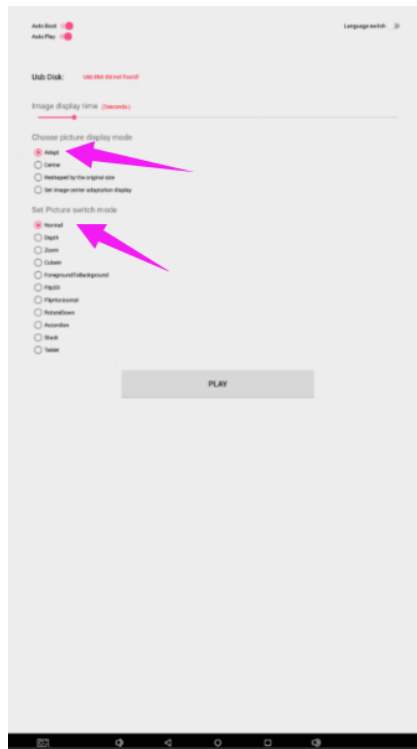

Step 8: Select Play and your slide show will begin playing



## How to Delete the media files :

Step 1: Open the Android launcher screen and click the explorer app

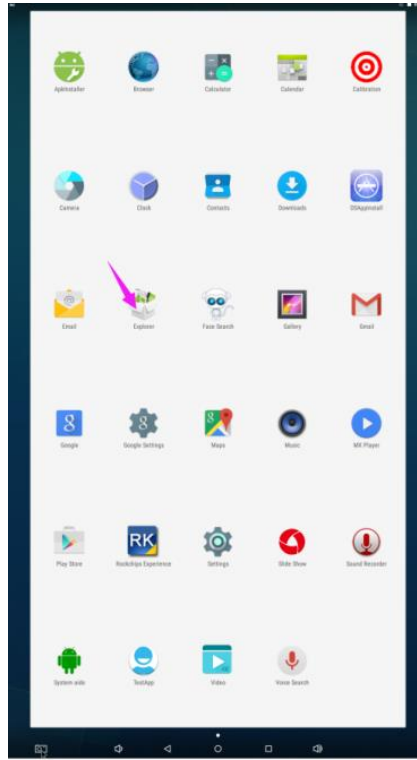
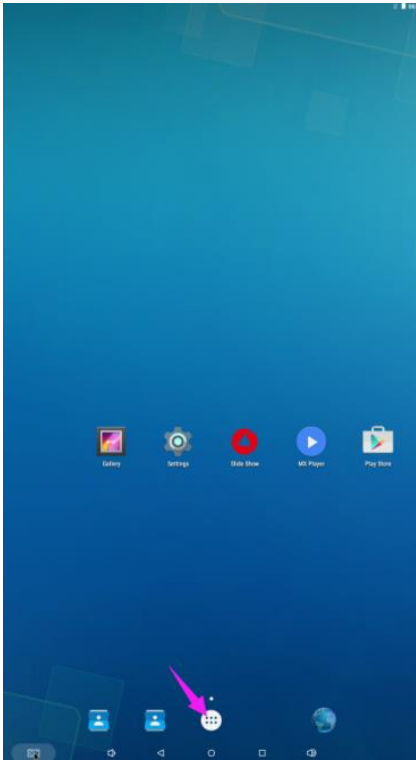

Step 2: Click home button and go to the NAND FLASH menu you will see the MediaFolder open it

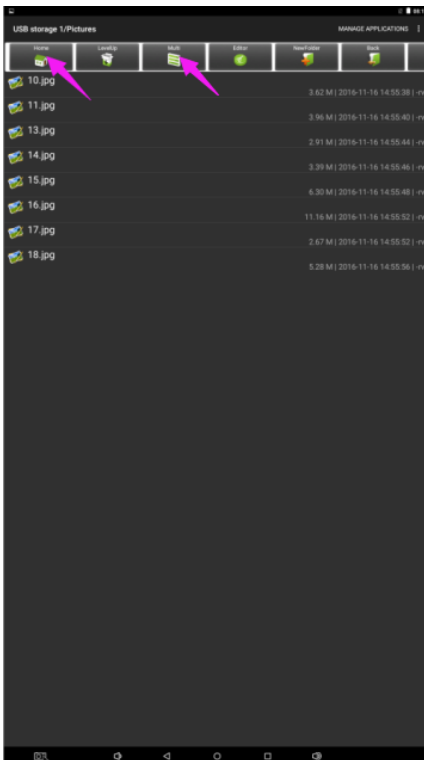



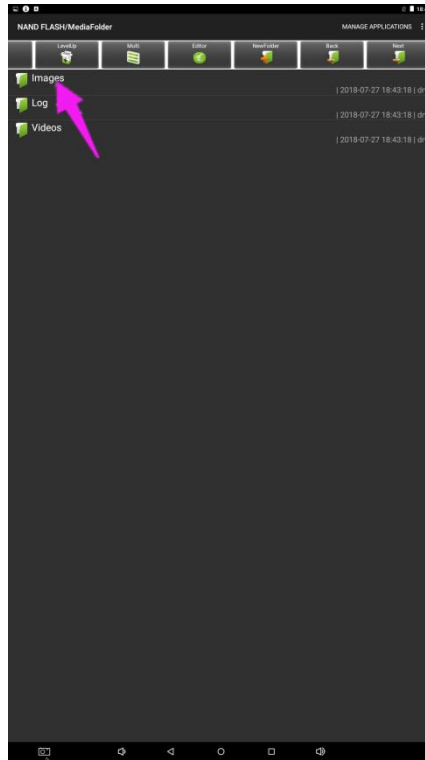
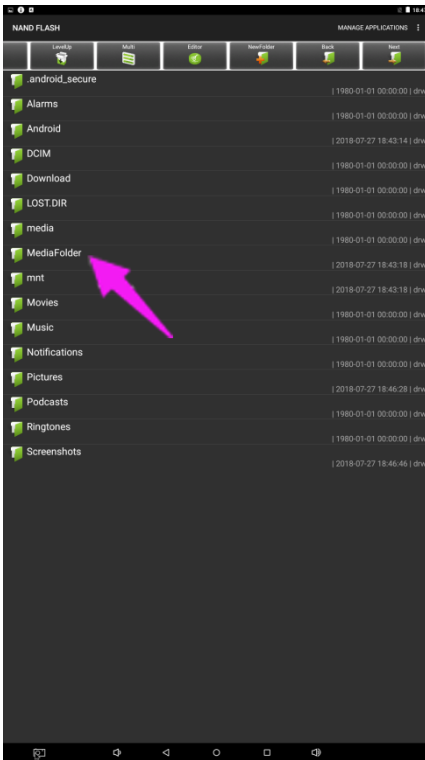

Step 3: At the Image or Video folder select the media files which you want to delete. Then click the edit button at the top of the screen, the pop menu will show. Then click the Delete command button and the files will be deleted.

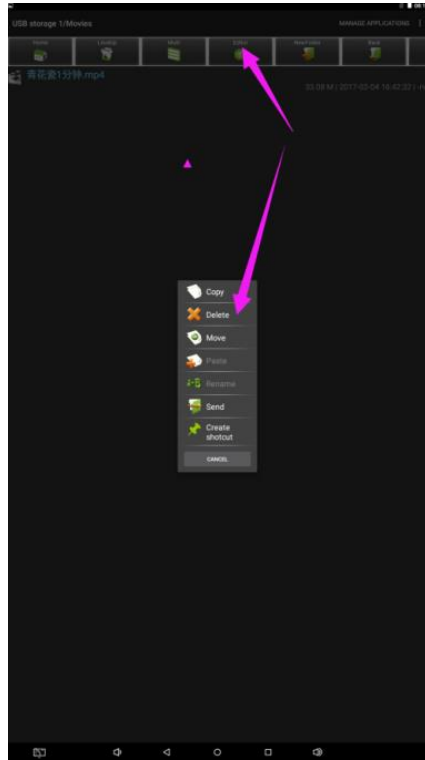
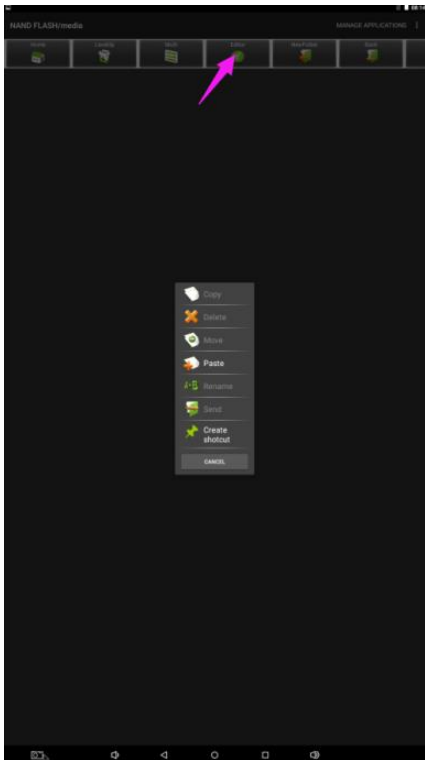

## Factory Reset:

1. Step 1, get into Settings, then click "Backup & reset" (Fig. 1)
2. Step 2, click "Factory data reset" (Fig. 2)
3. Choose "Erase SD card", then click "RESET DEVICE" to get the unit to Factory Reset (Fig. 3)

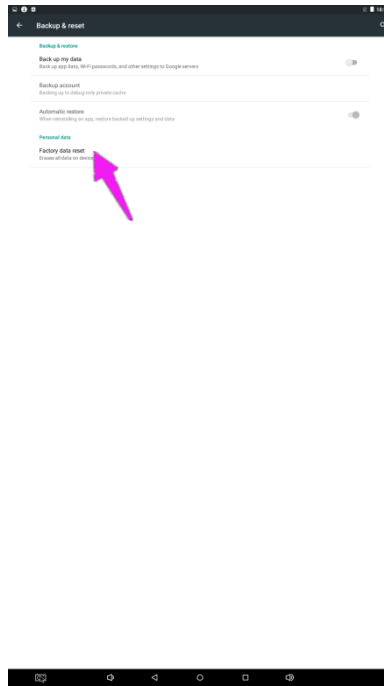
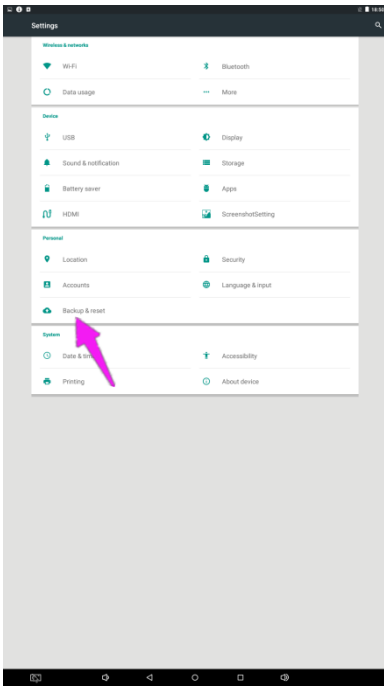

## Screen Rotate:

1. Step 1: Click the Main Apps button (⊞) in the Home page to enter the "APPS" menu interface (Fig. 1)
2. Step 2: Click "System aide" into Fig. 2
3. Step 3: Choose the degree you would like to Rotate screen, then click "Confirm", after a moment, the screen will be rotated (Fig. 3)

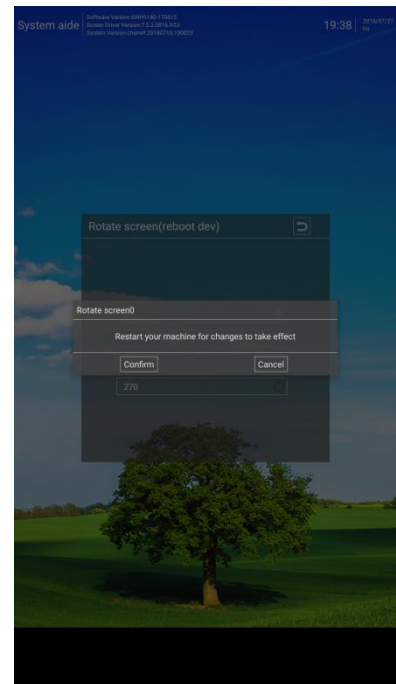
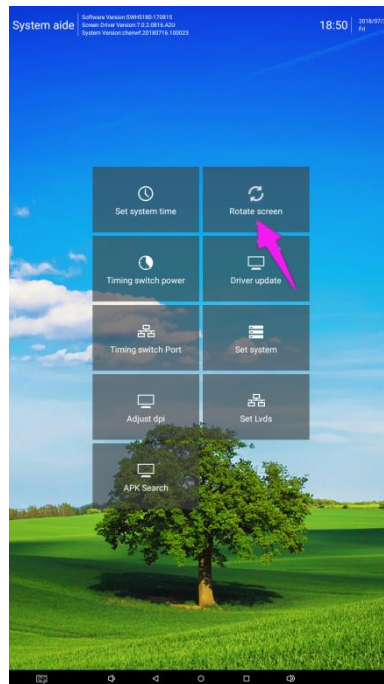
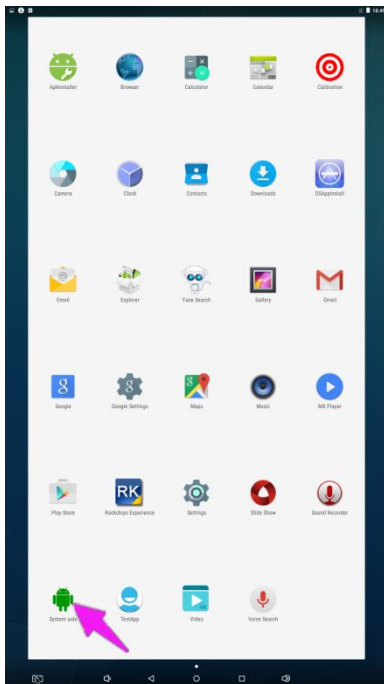

## Choose System Language:

1. Step 1: Get into Settings, then click “Language & input” (Fig. 1)
2. Step 2: Click “Language”, then you can choose the system language accordingly (Fig. 2)

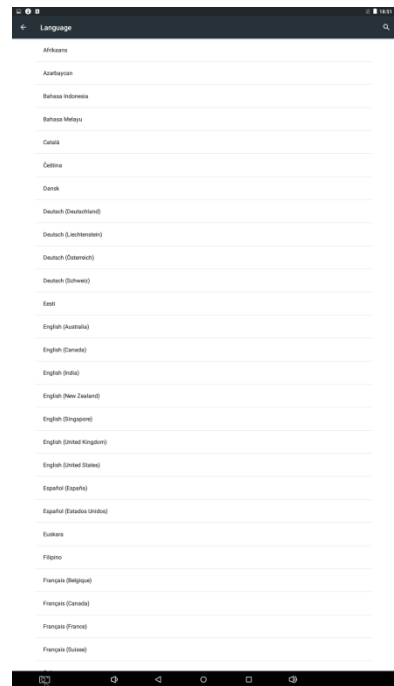
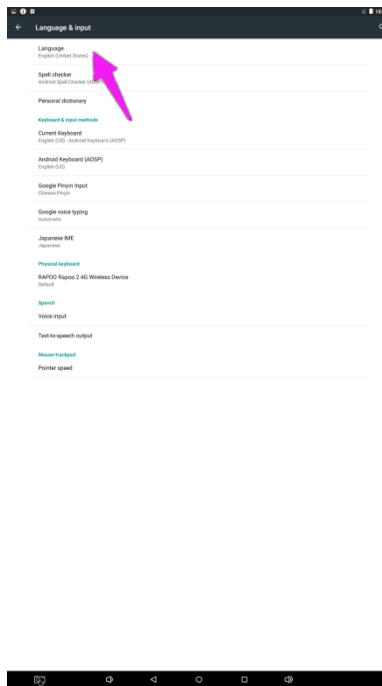
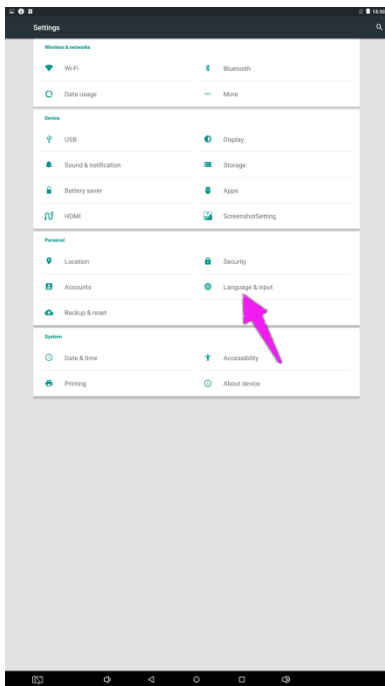



## Technical Specifications

	Model	Parameters
Panel	LCD Size	32"
	Panel Model	LD320DUE-FHB1
	Light Source	LED backlight
	Resolution	1920*1080 (pixels)
	Brightness (typ.)/(min)	400cd/m <sup>2</sup> (typ.)
	Contrast (typ.)	1000:1 (typ.)
	Response (ms)	10ms (typ.)
	Pixel Pitch	0.36375 (H) mm * 0.36375(V) mm
	Refresh Rate	60Hz
	Viewing Angle	178° (H)/178° (V)
	Life	30,000hrs (min)
	Color Saturation	68%
	Viewable Area	698.4(H) mm *392.85(V) mm
	Chromaticness	16.7M
Scheme	Rockchip	RK3288
Power Supply	Voltage	100V~240V, 50-60Hz
	Power Consumption	≤60W
	Standby Power (Watt)	TBD
Environment	Operating Temperature (°C)	0~40°C
	Storage Temperature (°C)	-10~60°C
	Storage Humidity	10~60% RH Non-condensing
	Operating Humidity	20~85% RH Non-condensing
	Maximum Operating Time (hrs/day)	18 hours
Functions	Operating System	Android 5.1.1
	Processor	RK3288, quad-core
	RAM	2G
	Built-in Memory	8G

Functions	Decoding Resolution	1080P FHD compatible
	Playback Mode	Support loop, inter-cut, timer, shim, etc.
	Compatible Network	Ethernet, 3G, 4G
	Supported Video Files	AVI, MPEG4, WMV, MKV, FLV, MP4, MOV
	Supported Photo Files	JPG, JPEG, BMP, PNG, GIF
	Supported Audio Files	MP3
	Audio Output	Left and Right, 2 Channels
	RTC (Real-Time Clock)	Yes
	Schedule Power on/off	Yes
	System Update	USB compatible
	App Installation	Support download and installation
I/O Interfaces	TF	1
	Ethernet	1 (RJ45)
	HDMI	1
	VGA	1
	Audio Out	N/A
	USB 2.0	2
	SIM	1
Structure	Net Weight	16.5kg
	Gross Weight	26kg
	Unit Dimensions (W*D*H)	449*56*1334mm
	Package Dimensions (W*D*H)	635*208*1510mm
	Shell Material	Aluminum profile/sheet metal
	Shell Color	Silver/black
Language	OSD	English/Simplified Chinese

## Troubleshooting the Digital Signs – DGAFR32, DGAFR43

Issue	Probable Cause	Solutions
● No picture or sound	<ul style="list-style-type: none"> <li>➤ Unit not plugged into wall outlet</li> <li>➤ Power cord not properly connected to the terminal on the back of the unit.</li> <li>➤ Unit not powered on</li> <li>➤ Wall outlet not working</li> </ul>	<ul style="list-style-type: none"> <li>□ Check that the unit is plugged into wall outlet.</li> <li>□ Confirm that the power cord is connected to the terminal on the back of the unit.</li> <li>□ Turn the on/off toggle switch located on the back of the unit, lower center, to the “on” position.</li> <li>□ Unplug unit, wait 20 seconds, plug unit back into outlet and try again.</li> <li>□ Make sure that outlet is working by plugging in a different electrical device.</li> <li>❖ <b>If all of the above have been checked and the issue is not resolved, contact a customer service representative.</b></li> </ul>
● No sound (but picture is working)	<ul style="list-style-type: none"> <li>➤ Volume not adjusted on the remote control.</li> <li>➤ Content/Video does not have sound.</li> <li>➤ Content format is not compatible.</li> <li>➤ Speakers do not work.</li> </ul>	<ul style="list-style-type: none"> <li>□ Adjust volume using the remote control</li> <li>□ Confirm content is one of the following compatible formats: AVI, MPEG4, WMV, MKV, flv, MP3, MP4, MOV.</li> <li>□ If unit is connected to Wi-Fi, go to YouTube and play video that has sound</li> <li>□ Unplug unit, wait 20 seconds, plug unit back into outlet and try again.</li> <li>□ Try playing the content on a different device (smart phone, computer or tablet)</li> <li>❖ <b>If all of the above have been checked and the issue is not resolved, contact a customer service representative.</b></li> </ul>
● No picture (but sound is working)	<ul style="list-style-type: none"> <li>➤ Content file damaged.</li> <li>➤ Content format is not compatible.</li> <li>➤ Screen damaged or defective.</li> </ul>	<ul style="list-style-type: none"> <li>□ Confirm content is one of the following compatible formats: AVI, MPEG4, WMV, MKV, flv, MP3, MP4, MOV.</li> <li>□ Try playing the content on a different device (smart phone, computer or tablet)</li> <li>□ Unplug unit, wait 20 seconds, plug unit back into outlet and try again.</li> <li>❖ <b>If all of the above have been checked and the issue is not resolved, contact a customer service representative.</b></li> </ul>
● Remote control not working	<ul style="list-style-type: none"> <li>➤ Batteries not inserted properly.</li> <li>➤ Batteries are dead.</li> <li>➤ Standing too close or too far from the unit.</li> </ul>	<ul style="list-style-type: none"> <li>□ Check that battery is inserted properly with positive and negative orientation.</li> <li>□ Insert new batteries.</li> <li>□ Stand within 1 foot of the front of the unit and point the remote directly at the sensor (green dot)</li> <li>❖ <b>If all of the above have been checked and the issue is not resolved, contact a customer service representative.</b></li> </ul>

<ul style="list-style-type: none"> <li>● No Wi-Fi signal</li> </ul>	<ul style="list-style-type: none"> <li>➤ Wi-Fi is not turned on in product settings.</li> <li>➤ Wi-Fi is not connected to a network</li> <li>➤ Low or no signal from the router</li> <li>➤ Antenna is missing or not pointed upward.</li> <li>➤ Damaged PC board</li> </ul>	<ul style="list-style-type: none"> <li>□ Check that Wi-Fi is turned on in settings <ul style="list-style-type: none"> <li>○ Click the settings icon from the Android home screen. </li> <li>○ Click "Wi-Fi".</li> <li>○ Click the on/off icon in the upper right hand corner to turn on Wi-Fi. </li> <li>○ "On" will appear on the upper left hand side.</li> <li>○ Then select your Wi-Fi network</li> </ul> </li> <li>□ Confirm that the antenna is in place and pointed upward.</li> <li>□ Check that other devices are receiving the signal. <ul style="list-style-type: none"> <li>○ <b>If other devices are not receiving the Wi-Fi signal, please contact your internet service provider.</b></li> </ul> </li> <li>□ Unplug or reset the router and wait for 20 seconds. Restart the router and check.</li> <li>❖ <b>If all of the above have been checked and the issue is not resolved, contact a customer service representative.</b></li> </ul>
<ul style="list-style-type: none"> <li>● Parts missing or Damaged</li> </ul>	<ul style="list-style-type: none"> <li>➤ Parts missed during manufacturing. (No charge for replacements)</li> <li>➤ Parts lost or damaged by the customer. (There is charge for replacements)</li> </ul>	<ul style="list-style-type: none"> <li>❖ <b>Contact a customer service representative.</b></li> </ul>
<ul style="list-style-type: none"> <li>● Having problems with installing software or getting content to play</li> </ul>	<ul style="list-style-type: none"> <li>➤ Did you purchase the DisplayIt!Xpress software from Displays2go?</li> <li>➤ Did the customer purchase or downloaded another 3<sup>rd</sup> party software onto the product?</li> </ul>	<ul style="list-style-type: none"> <li>□ If you purchased DisplayIt!Xpress software from Displays2go or from Best Wave directly, please contact Best Wave at <b>support@bestwave.com or (480)368-8900 ext. 2</b></li> <li>□ If you purchased or downloaded another 3<sup>rd</sup> party software onto the product, please contact the 3<sup>rd</sup> party software company's customer support for assistance.</li> </ul>
<ul style="list-style-type: none"> <li>● Cannot upload content</li> </ul>	<ul style="list-style-type: none"> <li>➤ Content format is not compatible.</li> <li>➤ Content files are too large.</li> <li>➤ Port being used is defective</li> <li>➤ App being used to play content is defective.</li> <li>➤ Android board is defective.</li> </ul>	<ul style="list-style-type: none"> <li>□ Confirm content is one of the following compatible formats: AVI, MPEG4, WMV, MKV, flv, MP3, MP4, MOV.</li> <li>□ Confirm file size is less than available space.</li> <li>❖ <b>If all of the above have been checked and the issue is not resolved, contact a customer service representative.</b></li> </ul>

<ul style="list-style-type: none"> <li>● Issues using pre-installed apps</li> </ul>	<ul style="list-style-type: none"> <li>➤ Mistake in storing content to NAND Flash (shown on pg. 11)</li> <li>➤ App is defective</li> <li>➤ Android board is defective.</li> </ul>	<ul style="list-style-type: none"> <li>□ SlideShow App steps Explorer &gt; Select USB &gt; Select Multi &gt; highlight files &gt; Editor &gt; Select Copy &gt; Home &gt; NAND &gt; MediaFolder &gt; Images&gt; Editor &gt; Paste <ul style="list-style-type: none"> <li>○ Open SlideShow app and select desired trasiitions, slide time and looping &gt; Play</li> </ul> </li> <li>□ MX Player steps &gt; Follow same steps as SlideShow App &gt; MediaFolder &gt; Video &gt; Editor &gt; Paste. <ul style="list-style-type: none"> <li>○ Open MX Player and select video to play.</li> <li>○ Loop video: While the video is playing, click on the video and there should be 3 dots in the top right corner. Click on the 3 dots &gt; play &gt; check desired Loop option</li> </ul> </li> <li>□ <b>If all of the above have been checked and the issue is not resolved, contact a customer service representative.</b></li> </ul>
---	---	--

## Cleaning and Maintenance

1. Avoid strong vibration or impact on the product.
2. Keep the product dry to avoid possible damage by moisture.
3. Don't place the product under direct sunlight which may shorten the service life of the screen.
4. Clean screen and product by using a glass cleaner.
5. If the product will be not used for a long time, pull out the power cord to prevent the internal short circuit or other potential dangers.



## Names and Contents of Toxic and Hazardous Substances or Elements in the Product

Part name	Toxic and hazardous substances or elements					
	Pb	Hg	Cd	Cr <sup>6+</sup>	PBB	PBDE
Display		○	○	○	○	○
Shell	○	○	○	○	×	×
Circuit board assembly *		○	○	○	○	○
Wires	○	○	○	○	○	○
Metal parts	○	○	○	○	○	○
Packaging materials*	○	○	○	○	○	○
Remote control		○	○	○	○	○
Speaker		○	○	○	○	○
Accessories*	○	○	○	○	○	○

\* : Circuit board assembly includes PCB and the electronic elements thereof;

Packaging materials include packaging box, styrofoam, etc.;

Other accessories include instruction manual.

○ : the content of the toxic and hazardous substances or elements in the part is lower than the limit specified in GB/T 26572-2011 standard.

× : the content of the toxic and hazardous substances or elements in the part is higher than the limit specified in GB/T 26572-2011 standard.

The table shows that the machine contains harmful substances inside. The data is provided by material suppliers and verified by the company according to the material type. Some materials contain harmful substances that can't be replaced in present technology. We are dedicated to improving this.

The EFUP of the product is ten years. The pollution control label is shown on the right.



The EFUP is valid only when the user operates in the normal conditions specified in the manual herein.

### ***Waste Electrical and Electronic Products Recycling and Disposal Regulations***

To protect the earth, if you do not need this product or its service life expires, please abide by your local ***Waste Electrical and Electronic Products Recycling and Disposal Regulations*** or send it to qualified local manufacture for recycling.

This Manual is for reference only and is subject to change without prior notice.