

LED Light Box

Wall Mounting Instructions

Note:

Please read all directions before mounting.

Step 1: Proper Handling

Light boxes must be held vertically when carried. Frame will bow if carried flat and could result in breakage of internal parts.

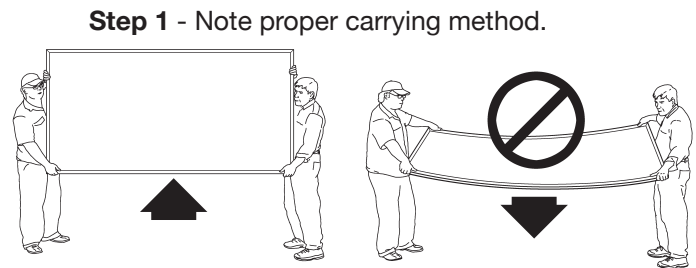

Step 2 - Level and mount hanging bracket.

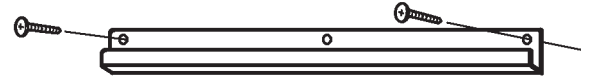

Step 2: Mounting Hanging Bracket on wall

Position hanging bracket on wall. Check to make sure bracket is level (use of a construction level is recommended). Screw bracket in place using screws and wall anchors provided.

Step 3 - Alternate bracket mounting configurations are dependant on frame size and orientation.

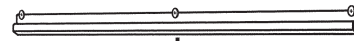

Step 3: Horizontal or Landscape Position

All frames include **two** hanging brackets. The longer bracket should be used when mounting on the longer length of the frame (in landscape position). The shorter bracket can be used when the frame is mounted vertically.

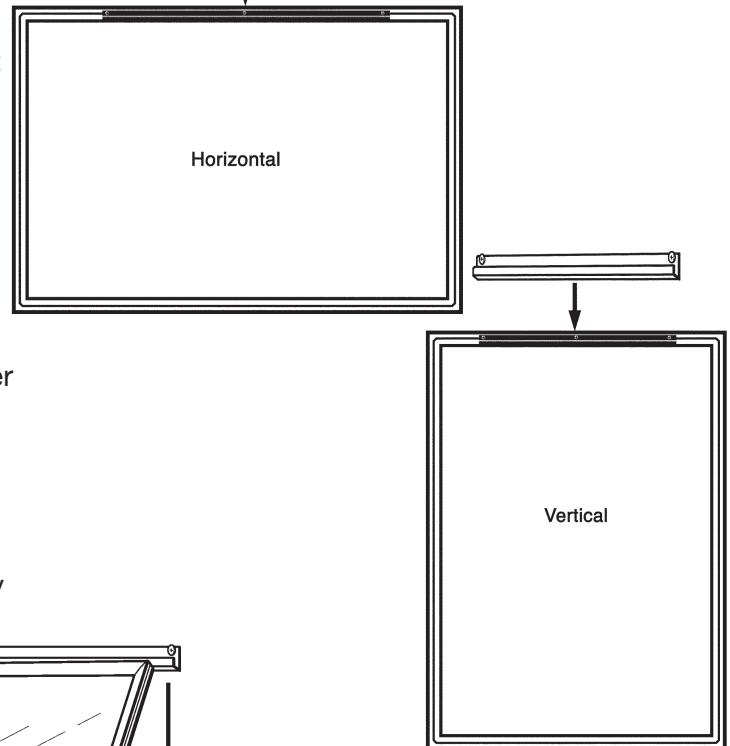

Step 4: Hanging Light Box on Wall Bracket

Before attaching light box to mounting bracket, angle frame slightly (approximately 30 degrees) to engage mounting bracket lip with channel on back of frame (see figure 3A). When frame channel is engaged with mounting bracket lower frame to rest parallel with wall (see figure 3B).

Step 5: Alternate Hanging Methods

Depending on the size of light box the method for mounting to wall may vary. Some light boxes may have holes drilled in the inside corners of the frame and may be mounted directly to wall without using the wall hanging bracket.

Questions? Call 1-800-572-2194.

Step 4 - Angle frame approximately 30° to engage frame channel with bracket. (See details below)

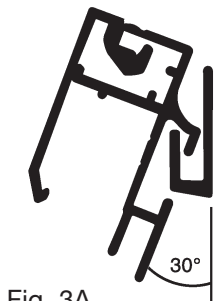

Fig. 3A

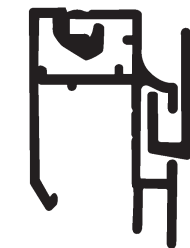
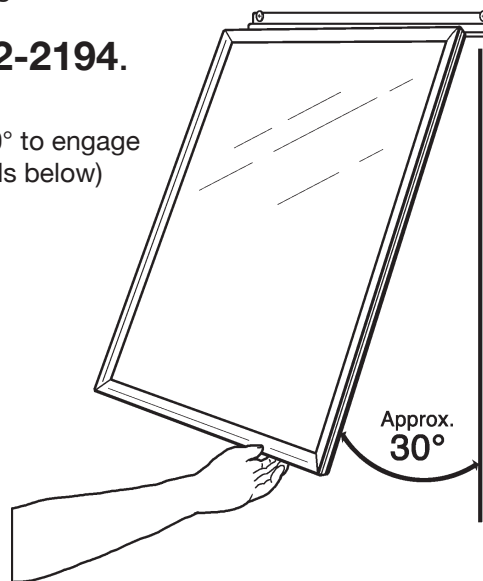
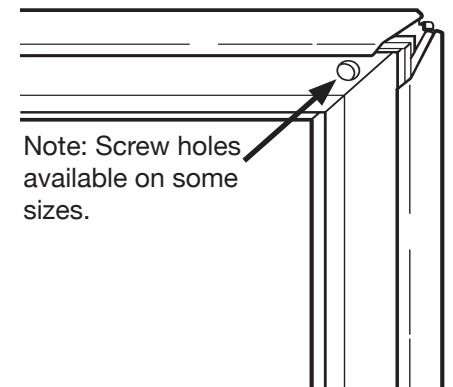

Fig. 3B



Step 5 - Alternate mounting methods for some light box sizes.



Note: Screw holes available on some sizes.

DISPLAYS2GO

DIVISION OF GEORGE PATTON ASSOCIATES, INC.

55 Broad Common Road, Bristol, RI 02809 • Phone 1-800-572-2194 Fax 401-247-0392