

ROT461 Assembly Instructions

Parts

	Description	QTY
A.	Upright	1
B.	Base	1
C.	Flat Head Screw	2
D.	Wrench	1
E.	Instructions	1

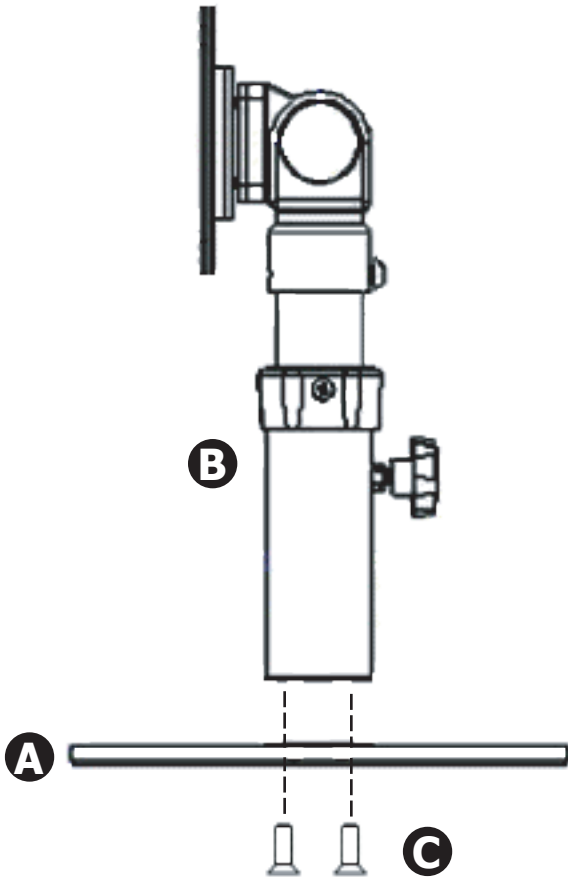

Fasten base (A) to upright (B) with provided flat head screws (C).



Bracket revolves about base 360°, tilts 180° and rotates from landscape to portrait.

