

10-14FT Pinwheel Hanging Banner

Frame Installation

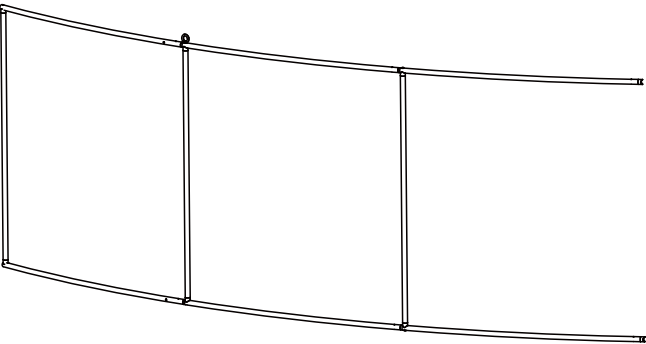
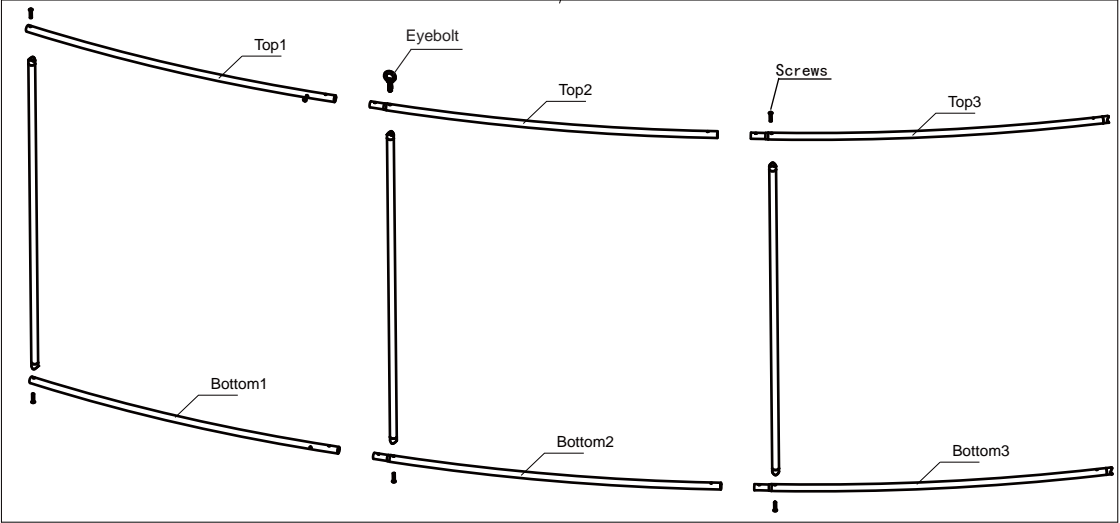
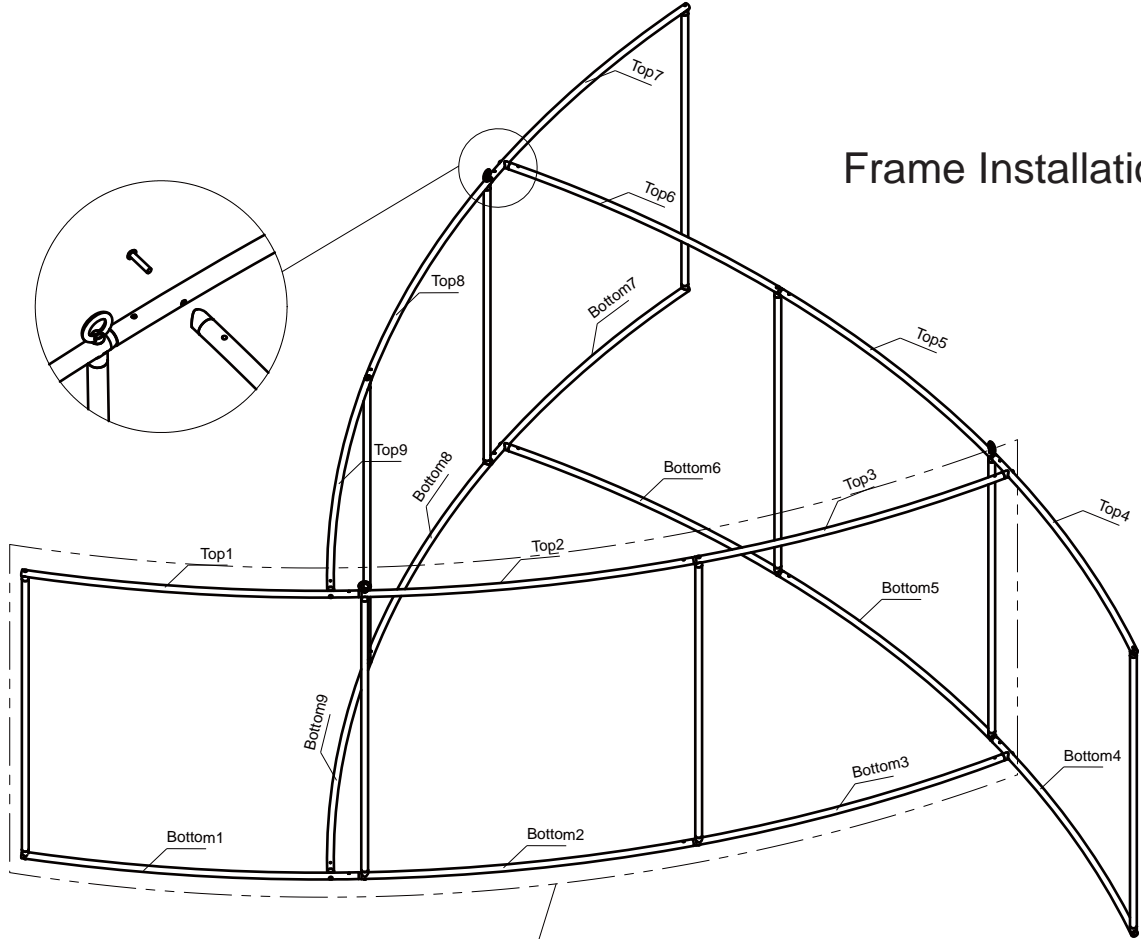

step 1:

Set up one side of the pinwheel frame per the label number above (as the left picture)

Do the same for the other 2 side frames.

10-14FT Pinewheel Hanging Banner

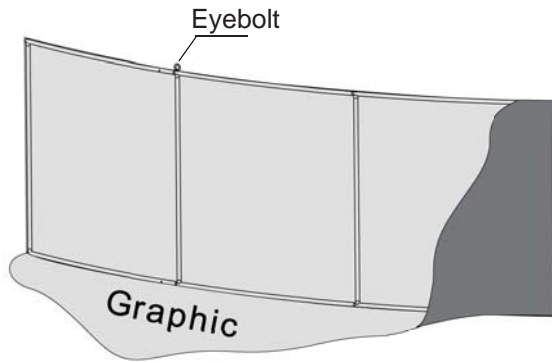

step 2:

Pull up the graphic to cover the assembled frame, then screw in the eye bolt as shown on the left.

Do the same for the other 2 side frames.

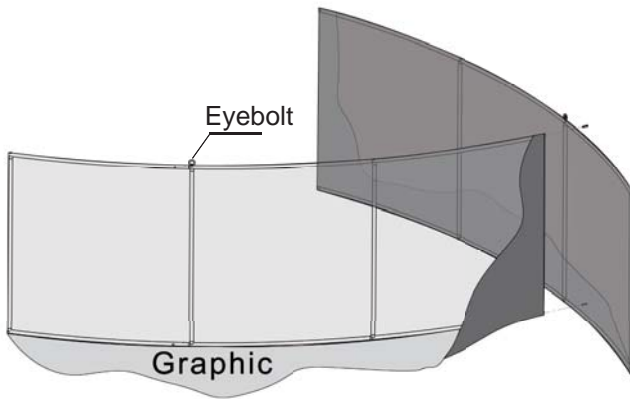

step 3:

Connect all 3 frames with graphic together.

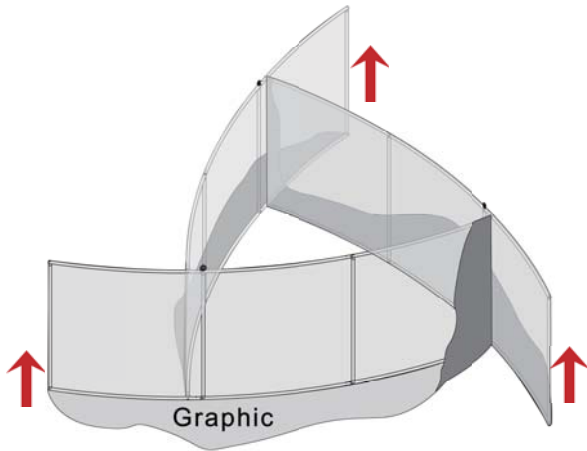

step 4:

After assembling all 3 side walls, close the zip at the top of the graphic on each wall.

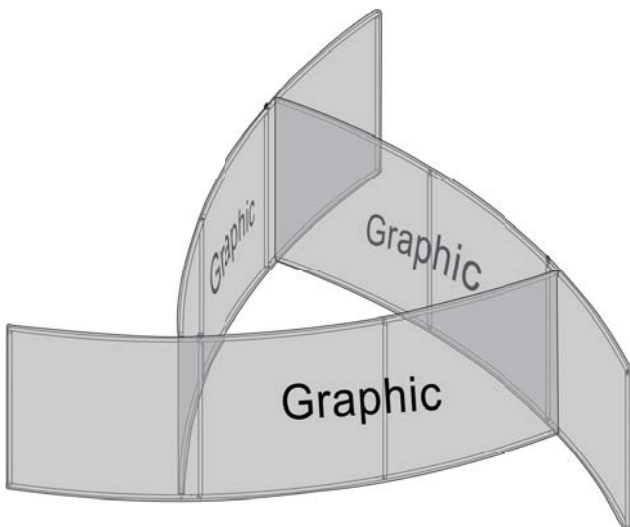
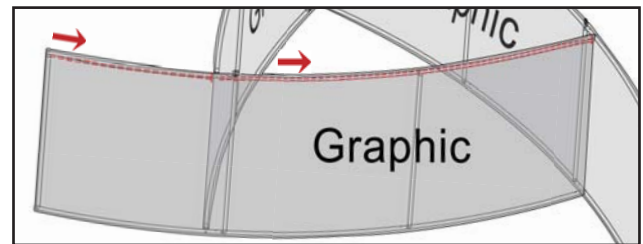

step 5:

Installation is completed.