

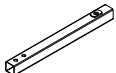







 Base Pole#1 1pcs		 Base Pole#2 2pcs		 Pole#1 1pcs	 3/8-16*50.8 hex head screw 1pcs	 small rod 1pcs	 Grid Rack 1pcs	<h1 style="text-align: center;">RTGRIDBK</h1> <h2 style="text-align: center;">Assembly Instructions</h2>
 1/4-20*12.7 hex head screw 4pcs	 Levelers 4pcs	 End caps 4pcs	 bearing 1pcs	 Pole#2 1pcs	 removable header 1pcs			

step 1



1. Joint the Base Pole#1 & Base Pole#2 using (2) 1/4-20*12.7 hex head screw. Then assembly the end caps and levelers (or wheels) into the base.

step 2

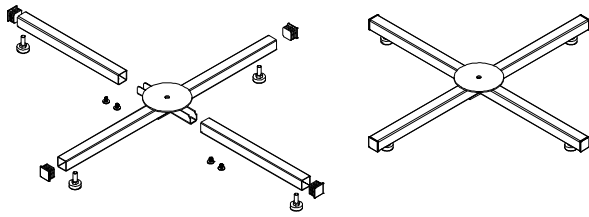
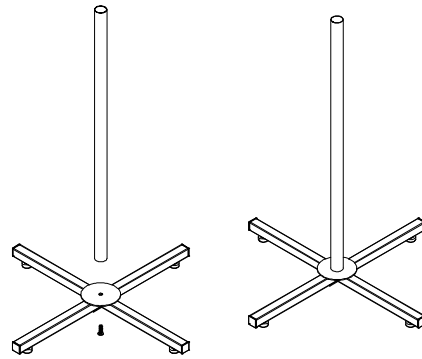

2. Please screw the Pole#1 into the base using (1) 3/8-16*50.8 hex head screw.

step 5

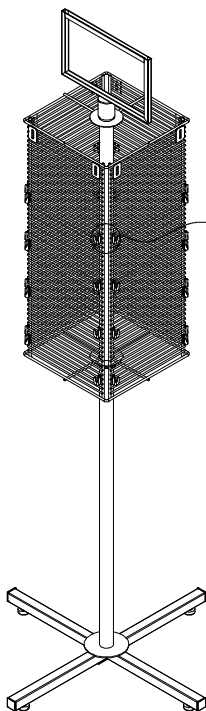

5. Put the removable header on top of Pole#2.

Complete, and product ready to use.

step 4

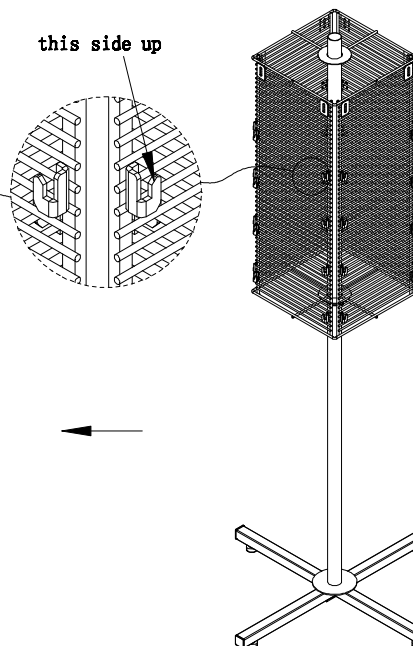

4. Insert the Grid Rack on pole.

Note: Please make sure the hooks are facing up.

step 3

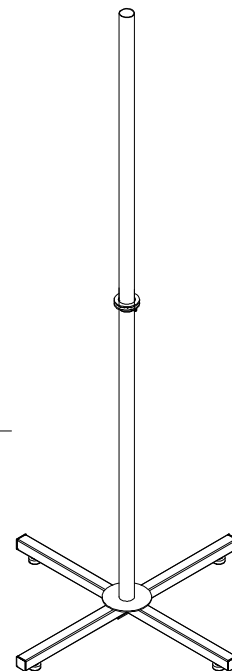

3. Assembly Pole#2 on top of Pole#1. Insert small rod and follow by bearing.

RM9

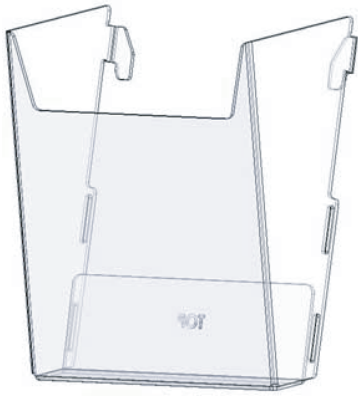

Top Pocket (1)

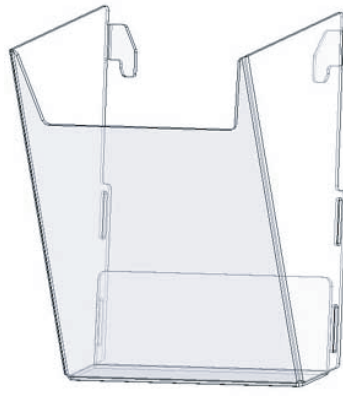

Lower Pockets (4)

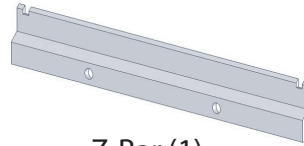

Z-Bar (1)

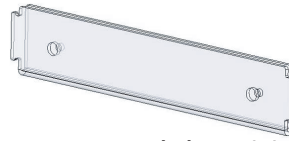

Lower stabilizer (1)



Screw (4)

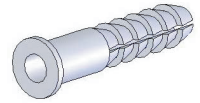

Drywall Anchor (4)

1. Place z-bar in desired location on a wall and mark the holes using a pencil. Remove z-bar and drill two 7/32 holes. Insert anchors and attach z-bar with screws.

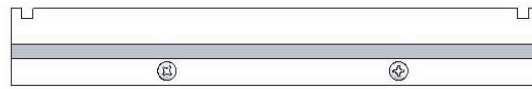

2. Take the pocket labeled "TOP" insert tabs into z-bar secured to the notches on the z-bar.



3. Attach following pockets by flexing sides of the pocket and insert tabs into slots on top pocket. Choose slots for full version or half version, repeat for remaining pockets.

4. After installing last pocket, make two marks on the wall at the bottom of slots (see images below), remove last pocket, align stabilizer to marks, and mark the holes on the wall. Drill 7/32" holes, install stabilizer using provided anchors and screws. Reinstall last pocket and attach tabs to the catches on the lower stabilizer.

