

# SLTVSTNBK

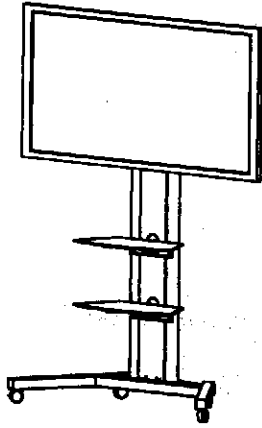









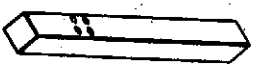
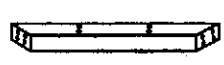
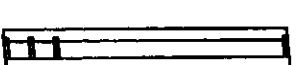
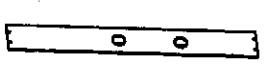



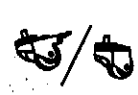
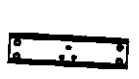



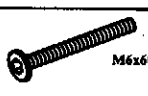

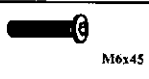

## USING NOTICE

- (1) This stand suitable for in-house use.
- (2) Please move this stand gently with two person.
- (3) Suitable for LCD/ LED&Plasma TV's with screen sizes up to 65"
- (4) Max TV Load: 60 kg

## SAFETY WARNING

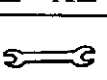
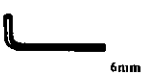
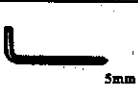
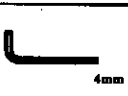
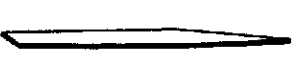
- (1) Don't climb or sit on the stand.
- (2) Don't place very hot or very cold things on the glass surface.
- (3) Don't touch the glass surface with hard and acute object.
- (4) Don't use causticity or powder contained cleanser to clean the glass surface.

 A x2	 B x1	 C x1	 D x1	 E x1
 F x2	 G x2	 H x2	 I x4	 J x2
 K x2	 L x8	 M x4	 N x8	 O x10
 P x20	 Q x4	 R x4	 S x4	 T x2
 U x4	 V x12	 W x6	 X x6	 Y x1
 Z x1	 a x1	 b x1	Screws for TV C x1 Pack	 d x2
 e x1				

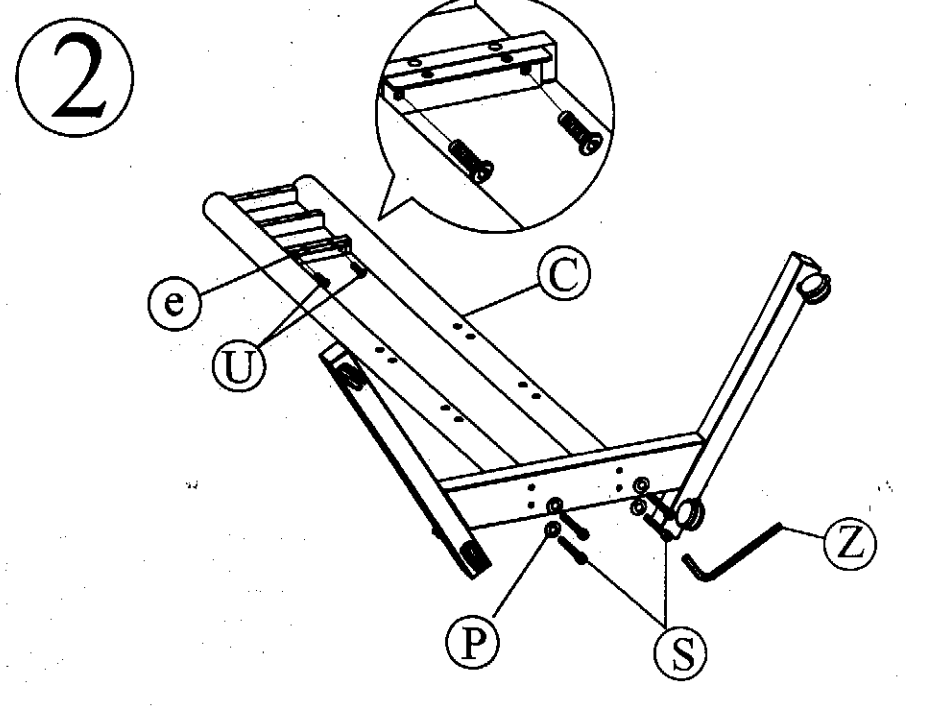
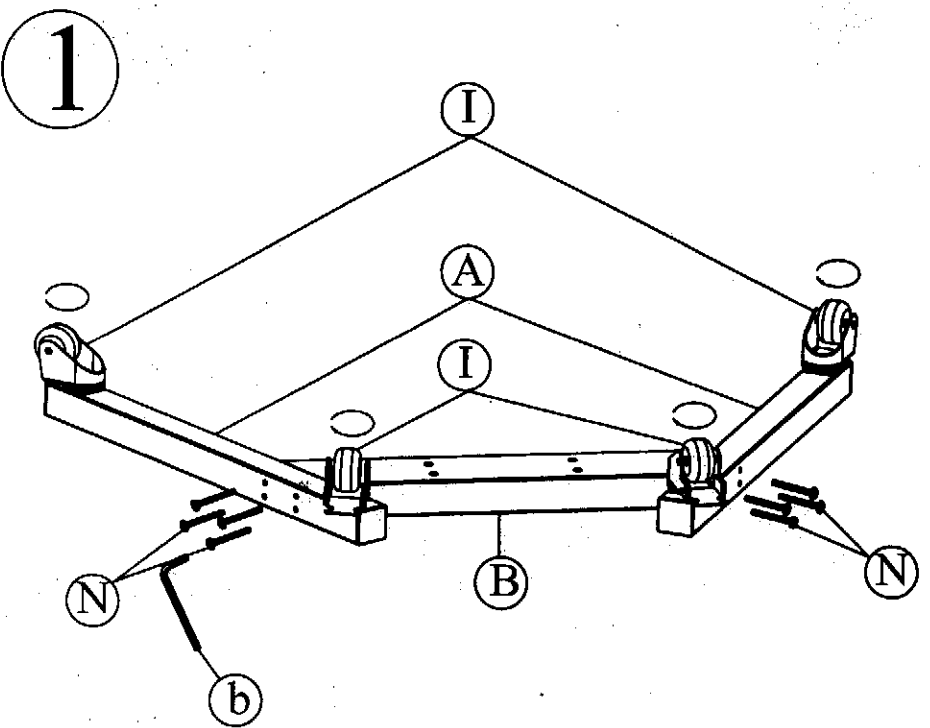

3

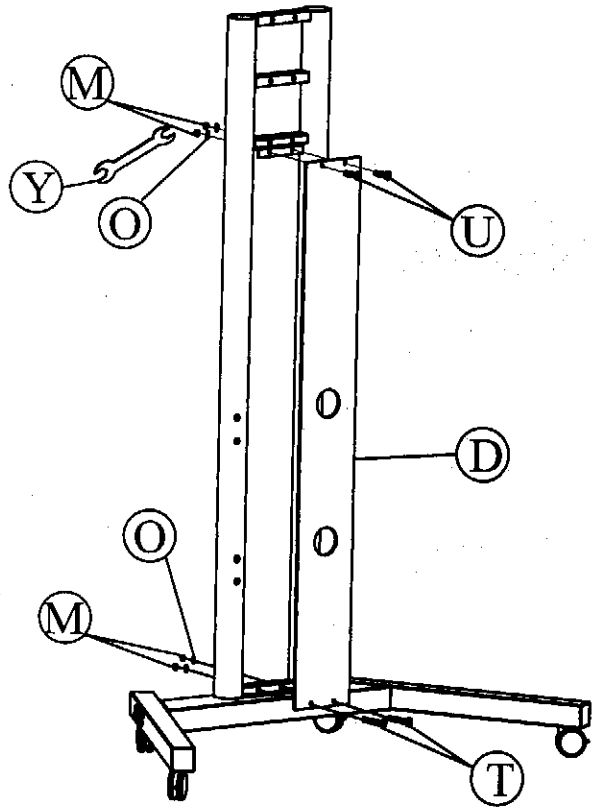

4

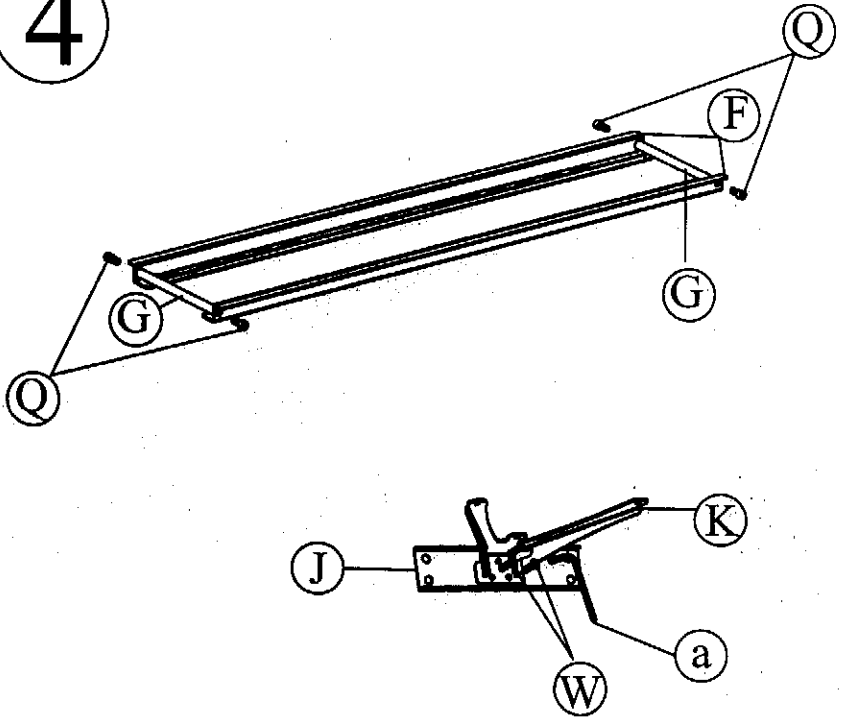

5

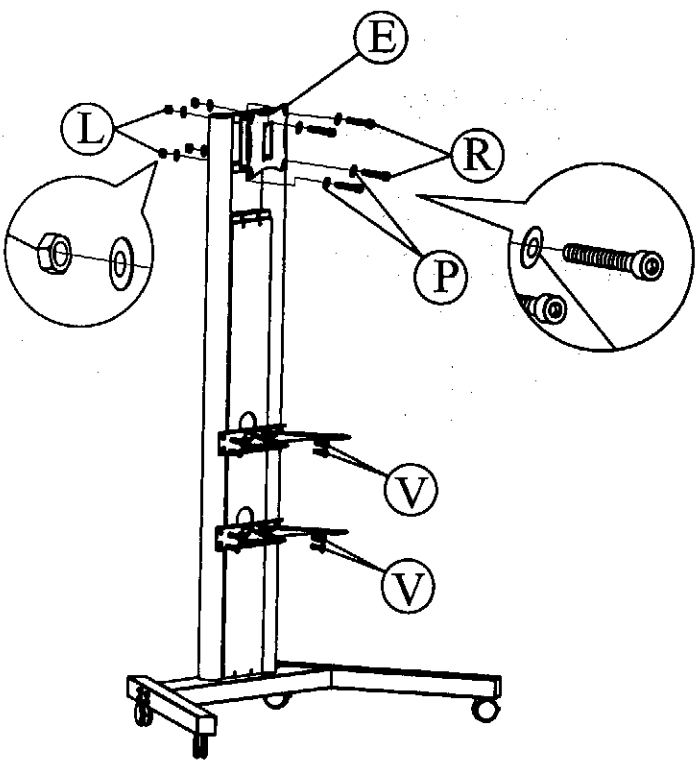

6

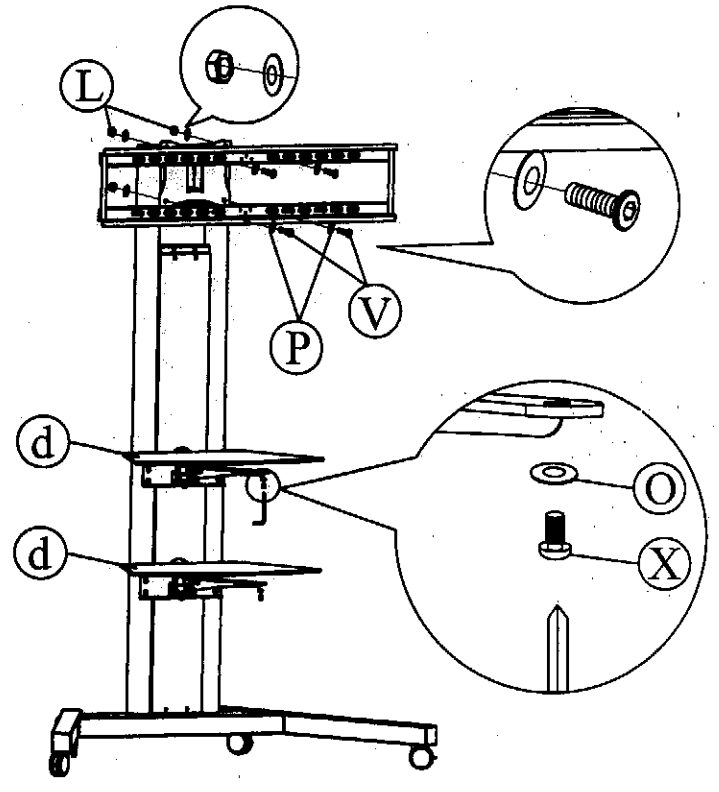

7

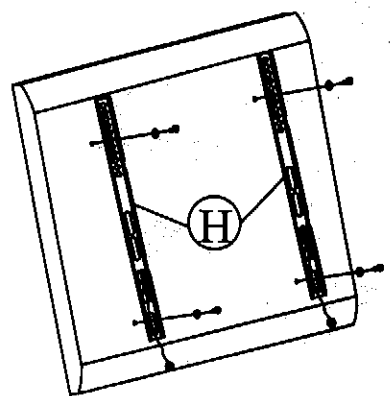

8

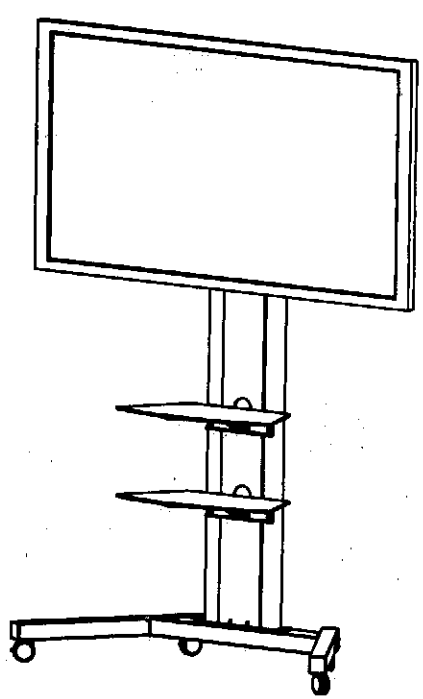

Choose right screws for TV

No.	Part Description	Part Sketch Map	Qty
1	M8X16		4
2	M8X40		4
3	M6X12		4
4	M6X35		4
5	Space		4
6	Ø16 x Ø8.5 Washer		4
7	Ø16 x Ø6.5 Washer		4

Screws for TV (PACK) C