

SQRHB1048 -10'w x 48"h

Square Hanging Banner

Assembly Instructions

Parts list:

- A: (16) Long Bar
(8) Right Side + (8) Left Side
- B: (4) Short Bar
- C: (4) Long Screw
- D: (12) Short Screw
- E: (4) Curved Side Support
- F: (1) Wirerope
- + Extra / Replacement Pieces.

A-Right (x8)
A-Left (x8)
B (x4)
E (x4)
C (x4)
D (x12)

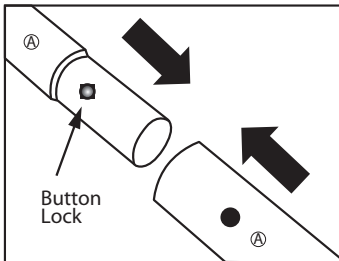
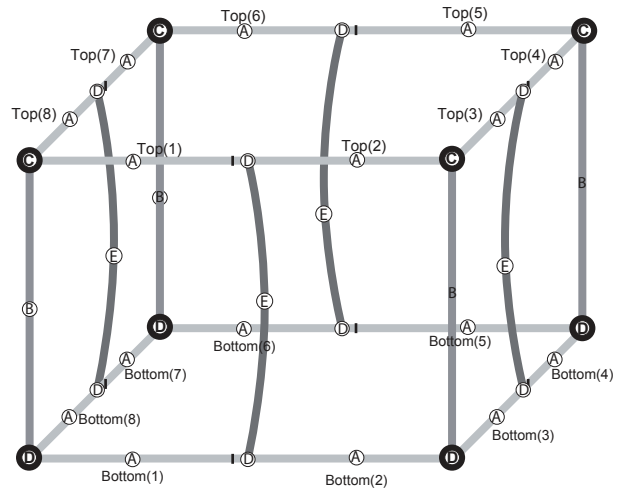

Connect (1) A-Left and (1)A-Right together to make a side of your square. Do this 4 times so you have the 4 sides of your square support.

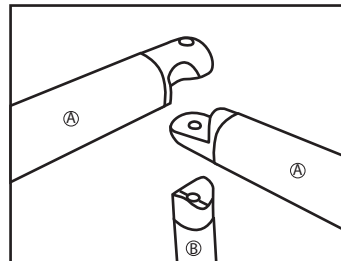

Align the ends of the each side as show, making sure to align the grooves in each piece to properly align.

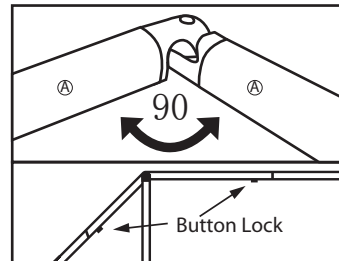

Please note: A 90 degree angle should be formed. Please Note Button Locks should be facing downwards when assembling top frame, and upwards when assembling bottom frame.

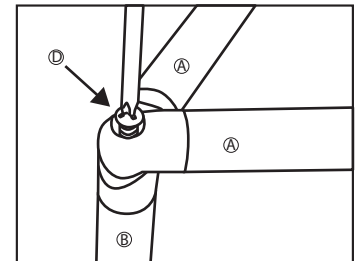

Using the Short Screws (D) attach the Short Bar (B) to each corner as pictured.

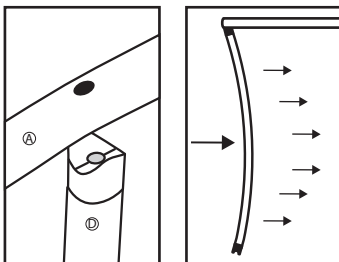

Attach the curved side supports (E) to the center of each side using a Shot Screw (C), making sure the curved side support bows in towards the center of the square.

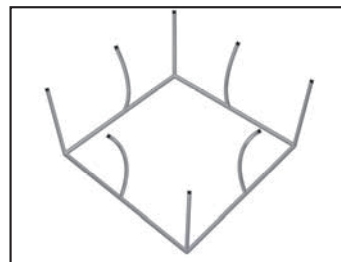

Set the assembled base on the ground so that the Short Bars are facing upward.

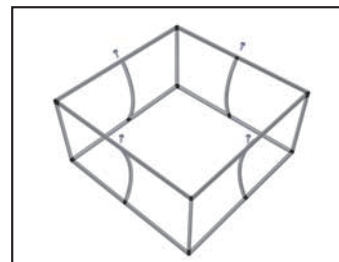

Attach the 2nd set of long bars (A) to the top of the curved short bars (E) using the remaining short screws (D).

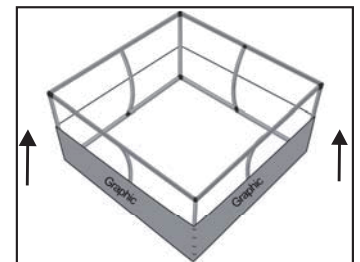

With the help of another person, position your graphic so the center seam is centered with the bottom square frame and the corners are aligned. Raise the graphic up over the frame.

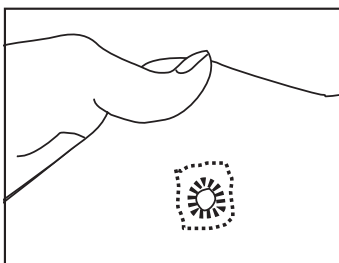

Please Note: Align each of the re-enforced holes with the top of each corner pole (4)

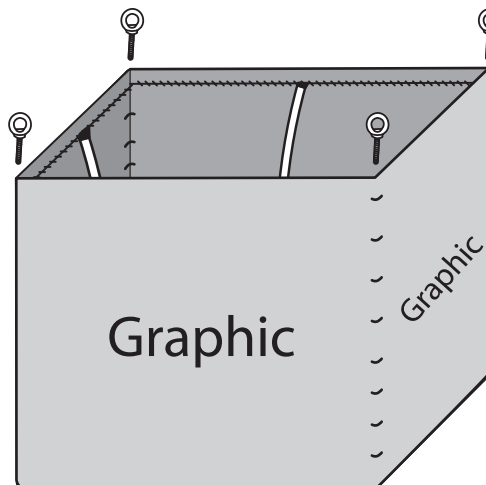

Align all holes then insert long screws and hand tighten

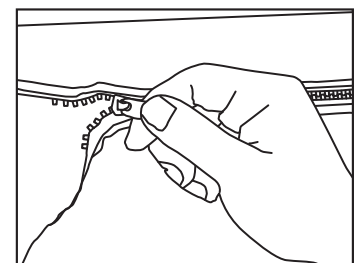

Once all long screws are in place, lift the inside of the graphic and zipper The sections together.

Hang your Banner by clipping the included wire to the eyelets on top of each long screw.

