

SPECIFICATIONS FOR SUPPLYING PRINT READY ARTWORK

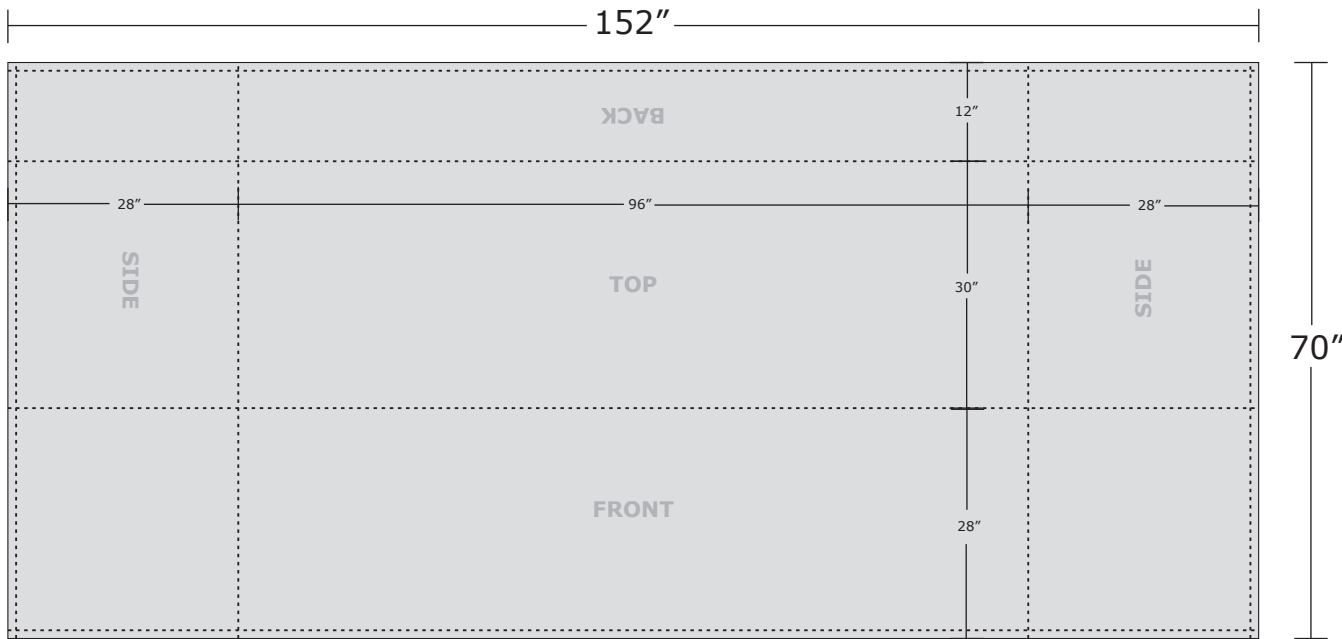

TABLE THROW **8' Custom Printed**

Total Graphic Area: 152" x 70"

Total Safe Area: 150" x 68"

DO NOT design any elements (text, Logos, etc.) within 1" of edge. Graphic will be stitched on all edges.

(For Reference Only)

FILE FORMATS

.JPG or .PDF

(.ai, .psd, .eps, .tiff)

ART GUIDELINES

- Files must be CMYK
- All Fonts must be created to Outlines or Supplied with your artwork
- Embed all images and support files
- Resolution must be 150 ppi at full size
- Please view your artwork at full size
- Background color / Image must extend to the edge of the artboard
- Make sure to turn off or delete all other layers on finished artwork before sending and make sure artwork is a flatten file (if using Photoshop).

TRANSMITTING FILES

ONLINE: www.postupstand.com/artupload

EMAIL: sales@postupstand.com